

Summer 2010

Application of life cycle assessment to estimate environmental impacts of surface coal mining

Ofentse Ditsele

Follow this and additional works at: http://scholarsmine.mst.edu/masters_theses

 Part of the [Mining Engineering Commons](#)

Department:

Recommended Citation

Ditsele, Ofentse, "Application of life cycle assessment to estimate environmental impacts of surface coal mining" (2010). *Masters Theses*. 4801.

http://scholarsmine.mst.edu/masters_theses/4801

This Thesis - Open Access is brought to you for free and open access by Scholars' Mine. It has been accepted for inclusion in Masters Theses by an authorized administrator of Scholars' Mine. This work is protected by U. S. Copyright Law. Unauthorized use including reproduction for redistribution requires the permission of the copyright holder. For more information, please contact scholarsmine@mst.edu.

**APPLICATION OF LIFE CYCLE ASSESSMENT TO ESTIMATE
ENVIRONMENTAL IMPACTS OF SURFACE COAL MINING**

by

OFENTSE DITSELE

A THESIS

**Presented to the Faculty of the Graduate School of the
MISSOURI UNIVERSITY OF SCIENCE AND TECHNOLOGY**

In Partial Fulfillment of the Requirements for the Degree

MASTER OF SCIENCE IN MINING ENGINEERING

2010

Approved by

Kwame Awuah-Offei, Advisor

Jason Baird

Samuel Frimpong

© 2010

Ofentse Ditsele

All Rights Reserved

ABSTRACT

Coal plays an important role in meeting the energy needs of the World. Given its abundance and low cost, its use is bound to increase with the growing energy demand. Despite its importance, there are concerns over coal's environmental burdens. In order to extract and use coal in a sustainable manner, sustainability assessment has to be comprehensive.

Life Cycle Assessment (LCA) provides systematic and quantifiable measures for assessing environmental burdens of products and processes. Extensive LCA work has been done on coal use, particularly in electricity generation, but, the coal mining stage has been neglected, for the most part. This has resulted in data gaps in the life cycle inventory (LCI) of coal and, consequently, in the LCIs for electricity and other products that are linked to coal. The situation has resulted in incomplete assessments of the sustainability of coal extraction and use, and potential for suboptimal strategies for reducing the potential impacts of coal, especially in the mining stage.

The aim of this study was to employ the general principles of the ISO 14040-49 series LCA standards, adapting them where necessary, to estimate the cradle-to-gate life cycle impacts of coal from surface mining in the United States. Five strip mines that produce bituminous coal were used as case studies. The study assessed the life cycle water use, land use, energy use, abiotic resource depletion and climate change impacts for each mine and compared the performances of the mines based on the impacts.

For the studied mines, the life cycle potential water use impact is 178 liters/tonne of processed coal at the mine gate. The potential land use impacts range from 3 to 10 m²-year/tonne. The potential energy use impacts vary from 97 to 181 MJ/tonne, the abiotic resource depletion impacts vary from 7.8 to 9.4 kg Sb-equivalent/tonne, and the climate change impacts range from 38 to 92 kg CO₂-equivalent/tonne. This study provides insight into contributions of mining processes to the impacts of coal. The results of the study contribute the much needed information to fill the data gaps in the LCI of coal, and provide baseline information that can aid the coal mining industry and public policy makers in the development of strategies and policies to sustainably exploit coal.

ACKNOWLEDGMENTS

This thesis was possible through the support and guidance from my advisor, committee members, employer, colleagues and family. I would like to express my deepest gratitude to my advisor, Dr Kwame Awuah-Offei, for his wonderful guidance throughout this research. His accommodating nature and never-ending patience with me ensured that this work was completed successfully. I greatly appreciate the invaluable input by way of comments and corrections from my graduate advisory committee members, Drs. Jason Baird and Samuel Frimpong.

Special thanks go to my employer, the Government of the Republic of Botswana, for offering me the opportunity to further my studies. I have to thank my boss, Mr Gabotshwarege Tshekiso, for his support and words of encouragement.

I am grateful to my family for their support throughout my schooling years. My fiancée, Kemiso, deserves a thank you for her patience, understanding, encouragement and support throughout this endeavor. Her words of wisdom have been helpful, particularly when things were tough.

This work is dedicated to my daughter, Antoinette (Othata), who has been a great source of motivation for me.

TABLE OF CONTENTS

ABSTRACT.....	iii
ACKNOWLEDGMENTS	iv
LIST OF FIGURES	ix
LIST OF TABLES	xi
ABBREVIATIONS	xii
SECTION	
1. INTRODUCTION	1
1.1. BACKGROUND	1
1.1.1. Importance of Coal..	1
1.1.2. Environmental Sustainability Evaluation in Coal Mining..	2
1.1.3. LCA in Evaluation of Mining Products..	5
1.2. STATEMENT OF PROBLEM.....	7
1.3. OBJECTIVES AND SCOPE OF RESEARCH.....	8
1.4. RATIONALE FOR STUDY	9
1.5. METHODOLOGY	10
1.6. STRUCTURE OF THESIS	10
2. LITERATURE SURVEY	12
2.1. ENVIRONMENTAL IMPACTS OF COAL.....	12
2.1.1. Climate Change.....	12
2.1.2. Energy Use.....	13
2.1.3. Resources Depletion For Fossil Fuels.....	14
2.1.4. Land Disturbance..	14
2.1.5. Water Use.....	15
2.1.6. Water Quality.....	15
2.1.7. Acidification, Photochemical Oxidation and Toxicity..	16
2.1.8. Solid Waste..	16
2.2. ENVIRONMENTAL SUSTAINABILITY IN MINING AND COAL ..	16
2.3. ENVIRONMENTAL ASSESSMENT TOOLS	20

2.3.1. Environmental Impact Assessment.....	21
2.3.2. Ecological Footprint.....	22
2.3.3. Risk Assessment.. ..	22
2.3.4. Ecological Risk Assessment.. ..	22
2.3.5. Material Flow Accounting.. ..	23
2.4. LIFE CYCLE ASSESSMENT FRAMEWORK	23
2.4.1. Development of LCA Methodology.. ..	24
2.4.2. Phases of LCA.. ..	27
2.4.3. Uses of LCA.	34
2.4.4. Strengths and Weaknesses of LCA.....	38
2.5. LCA APPLICATIONS TO MINING AND COAL	40
2.6. CHALLENGES IN APPLYING LCA TO COAL MINING.	44
2.6.1. Lack of Data.....	44
2.6.2. Limited Specificity to Mineral Products.....	45
2.6.3. Ambiguity of Results Due to Aggregation.. ..	46
2.6.4. Arbitrariness in Selection of Functional Unit	47
2.6.5. Arbitrariness in Selection of System Boundaries.. ..	48
2.6.6. Limited Awareness of LCA Methodology.	48
2.6.7. Lack of Expertise and Resources.....	48
3. GOAL AND SCOPE DEFINITION.....	49
3.1. GOAL OF THE STUDY	49
3.2. TYPE OF LCA.	50
3.3. TARGET AUDIENCE.	50
3.4. SOURCES AND SPECIFICITY OF DATA.....	50
3.5. BACKGROUND ON THE CASE STUDY MINES.....	51
3.5.1. Mines A1 and A2: Black Mesa and Kayenta.....	51
3.5.2. Mine B: Wildcat Hills Mine, Cottage Grove Pit.....	54
3.5.3. Mine C: Cottonwood Creek Mine.....	55
3.5.4. Mine D: Hume Mine.....	56
3.6. PRODUCT SYSTEM AND SCOPING.	57
3.6.1. Functional Unit.. ..	57

3.6.2. Selection of System Boundaries..	57
4. LIFE CYCLE INVENTORY ANALYSIS	65
4.1. WATER USE	65
4.2. LAND USE	65
4.3. COALBED METHANE EMISSIONS	66
4.4. ENERGY SOURCES	66
4.4.1. Electricity and Fuels	66
4.4.2. Explosives	71
4.5. LIFE CYCLE INVENTORY ANALYSIS RESULTS	72
5. LIFE CYCLE IMPACT ASSESSMENT	74
5.1. ASSESSMENT OF IMPACTS	74
5.1.1. Water Use Impacts	74
5.1.2. Land Use Impacts	74
5.1.3. Energy Use Impacts	78
5.1.4. Abiotic Resource Depletion Impacts	81
5.1.5. Climate Change Impacts	84
5.1.6. Performance Ranking	89
5.2. SENSITIVITY ANALYSIS	90
5.2.1. Energy Use Impacts	90
5.2.2. Resource Depletion Impacts	93
5.2.3. Climate Change Impacts	95
5.3. DATA QUALITY AND UNCERTAINTY ANALYSIS	98
5.3.1. Completeness of Data	98
5.3.2. Relevance of Data	98
5.3.3. Water Use Data	98
5.3.4. Land Use Data	99
5.3.5. Energy Consumption Data	99
5.3.6. Methane Emissions Data	99
5.3.7. Uncertainties Inherent in LCIA	100
5.4. IMPROVEMENT	100
5.4.1. Efficient Use of Land	100

5.4.2. Energy Use Efficiency.....	101
5.4.3. Coalbed Methane.....	101
6. CONCLUSIONS AND RECOMMENDATIONS FOR FUTURE WORK...	102
6.1. CONCLUSIONS.....	102
6.2. RECOMMENDATIONS FOR FUTURE WORK	105
APPENDICES	
A: INVENTORY ANALYSIS CALCULATIONS.....	106
B: LAND USE IMPACTS CALCULATIONS	118
C: SENSITIVITY ANALYSIS CALCULATIONS	125
D: GLOSSARY OF LCA RELATED TERMS.....	128
BIBLIOGRAPHY	136
VITA	153

LIST OF FIGURES

Figure 1.1. Processes in the cradle-to-gate life cycle assessment of coal.....	9
Figure 2.1. Standard of sustainability reporting in the mining industry	18
Figure 2.2. A generalized life cycle assessment model	24
Figure 2.3. SETAC 1993 LCA framework.....	27
Figure 2.4. LCA framework according to ISO 14041:1998	28
Figure 3.1. Locations of the case study mines	52
Figure 3.2. Initial product system model for cradle-to-gate assessment.....	58
Figure 3.3. Product system model after scoping.....	63
Figure 3.4. Final system boundaries after scoping and consolidation	64
Figure 5.1. Contributions to area disturbance and land occupation impacts	78
Figure 5.2. Contributions to energy use impacts by different energy sources.....	79
Figure 5.3. Potential energy use impact versus normalized scale of production.....	80
Figure 5.4. Contributions to abiotic resource depletion impacts by fossil fuels.....	83
Figure 5.5. Resource depletion impact versus production scale	84
Figure 5.6. Contributions to climate change impacts by different gases	86
Figure 5.7. Contributions to potential climate change impacts by source	87
Figure 5.8. Climate change impact versus energy use impact.....	88
Figure 5.9. Potential climate change impact versus production scale	89
Figure 5.10. The effects of changing the electricity generation resource mix on potential energy use impacts	91
Figure 5.11. Sensitivity of energy use impacts to variations in electricity and diesel use.....	92
Figure 5.12. The effects of change in electricity generation resource mix on potential resource depletion impacts	93
Figure 5.13. Sensitivity of resource depletion impacts to variations in electricity and diesel use	94
Figure 5.14. The effects of change in electricity generation resource mix on potential climate change impacts	96

Figure 5.15. Sensitivity of climate change impacts to variations in electricity, diesel and coalbed methane emissions	97
--	----

LIST OF TABLES

Table 1.1. Web survey results on environmental sustainability reporting in the US coal mining industry	4
Table 2.1. Cradle-to-gate LCIs for mining of different coal types	43
Table 3.1. Black Mesa and Kayenta parameters.....	53
Table 3.2. Black Mesa and Kayenta average data for 2004 and 2005.....	53
Table 3.3. General parameters for Cottage Grove Pit.....	54
Table 3.4. General parameters for Cottonwood Creek Mine.....	55
Table 3.5. General parameters for Hume Mine	56
Table 3.6. Land disturbance activities at Black Mesa and Kayenta complex.....	60
Table 3.7. Cut-off criteria used in the RMEE scoping	61
Table 3.8. Scoping of unit processes for energy sources and material inputs	62
Table 4.1. Land area disturbance by mine	66
Table 4.2. Energy consumption in the different mines per tonne of coal produced.....	68
Table 4.3. GHG emissions from fuel use in the mines based on 1 tonne of coal	69
Table 4.4. The 2005 eGRID generation resource mixes for the US and three States.....	69
Table 4.5. Primary energy inputs for delivery of electricity and fuels to the mines based on 1 tonne of coal produced	70
Table 4.6. GHG emissions for production and delivery of electricity and fuels to produce 1 tonne of coal	71
Table 4.7. Explosives energy and emissions per tonne of coal mined	72
Table 4.8. Inventory analysis results for the different mines.....	73
Table 5.1. Land use impacts per tonne of coal produced.....	77
Table 5.2. Energy use impact indicators for the mines.....	79
Table 5.3. CML 2001 Abiotic Depletion Potentials for fossil fuels	82
Table 5.4. Resource depletion impacts for the mines	82
Table 5.5. AR4 - GWPs for 100 year time horizon	85
Table 5.6. Climate change impacts based on AR4 GWPs for 100 year time horizon.....	86
Table 5.7. Rankings of the mines' performances for each impact category.....	89

ABBREVIATIONS

ADP	Abiotic Depletion Potential
AMD	Acid mine drainage
ANFO	Ammonium Nitrate – Fuel Oil
APC	American Plastics Council
Btu	British thermal unit
CCPs	Coal Combustion Products
CFC	Chlorofluorocarbon
CH ₄	Methane
CO ₂	Carbon dioxide
CO ₂ -eq.	Carbon dioxide equivalent
DfE	Design for Environment
DOE	US Department of Energy
EC JRC	European Commission Joint Research Center
eGRID	Emissions and Generation Resource Integrated Database
EIA	Energy Information Administration
EIO-LCA	Economic Input-Output Life Cycle Assessment
EIS	Environmental Impact Statement
EMS	Environmental Management System
EPA	US Environmental Protection Agency
EPIC	Environment and Plastics Institute of Canada
ERA	Ecological Risk Assessment
EU	European Union
Ft	Foot
g	Gram
GHG	Greenhouse gas
REET	Greenhouse Gases, Regulated Emissions, and Energy Use in Transportation
GRI	Global Reporting Initiative
GWP	Global Warming Potential

H ₂ O	Water
IAI	International Aluminium Institute
IPCC	Intergovernmental Panel on Climate Change
IPP	Integrated Product Policy
ISO	International Standards Organization
ISO/TR	International Standards Organization/Technical Report
ISO/TS	International Standards Organization/Technical Specification
kg	kilogram
kWh	Kilowatt-hour
L	Liter
lb	Pound
LCA	Life cycle assessment
LCC	Life Cycle Costing
LCI	Life cycle inventory
LCIA	Life cycle impact assessment
LCVA	Life Cycle Value Assessment
LOI	Land Occupation Impact
NREL	National Renewable Energy Laboratory
m ²	Square meter
MFA	Material Flow Analysis
MJ	Megajoule
MMBtu	Million British thermal unit
MRI	Midwest Research Institute
MWh	Megawatt-hour
NEPA	National Environmental Policy Act
N ₂ O	Nitrous oxide
O ₂	Oxygen
OEM	Original Equipment Manufacturer
PWMI	Plastic Waste Management Institute
REPA	Resource and Environmental Profile Analysis
RMEE	Relative Mass-Energy-Economic value

Sb	Antimony
Sb–eq.	Antimony equivalent.
SETAC	Society for Environmental Toxicology And Chemistry
SMCRA	US Surface Mining Control and Reclamation Act
SO ₂	Sulfur Dioxide
TBtu	Trillion British Thermal Units
TWh	Terrawatt-hour
UN	United Nations
US	United States

1. INTRODUCTION

1.1. BACKGROUND

1.1.1. Importance of Coal. Coal plays an important role in today's society. It generates about one half (48.5% in 2008) of the electricity used in the United States (EIA, 2009a) and 39% of electricity worldwide (World Coal Institute, 2005). According to the Energy Information Administration (EIA), the US has the largest coal reserves in the world (262 billion tons of recoverable reserves) and mines over a billion tons (1.171 billion tons in 2008) of coal annually (EIA, 2009b). Projections up to the year 2030 predict that increases in coal consumption for electricity generation at both new and existing power plants, as well as due to commissioning of new coal-to-liquids plants, expected to be constructed in the future, will result in an annual coal production growth rate of about 0.6% (EIA, 2009c). Other than its use in electricity generation, coal is a vital feedstock in other industrial processes. Industries such as steel making, cement production, paper making and others, which produce goods essential for society's comfort and progress, depend on coal. Coal-to-liquid fuels conversion may possibly turn out to be a critical process across many nations in the future, given the limited reserves of crude oil which currently provides most of the liquid fuels.

The US produces coal from about 1,400 mines. The bulk of production is from surface coal mining operations, which account for about two thirds (69.5% in 2008) of total coal production (EIA, 2009b). Surface mining methods are important for extraction of coal as they are amenable to high productivity, allow good recovery rates and have lower safety hazards, compared to the underground mining systems.

Given that coal is the most abundant, inexpensive, and readily available energy source, it is bound to continue to play a big role in the future energy market (World Coal Institute, 2005; Mangena and Brent, 2006). Despite calls for greener sources of energy, it is not likely that coal would be significantly replaced in the near future by energy sources that are considered to have low impacts on the environment. This is due to the challenges associated with these energy sources. There are issues of availability and reliability that inhibit use of renewable energy sources such as solar and wind power in base power

generation at the scale of coal fired electricity generation plants. There are limited sites that are suitable for hydroelectric power generation and this limits the growth of electric power generation through this method. With regard to nuclear energy, there is some reluctance to accept an increase in its use because of safety concerns over nuclear generation plants and spent nuclear fuel waste, as well as security concerns over potential diversion to undesirable uses. The development and use of non-conventional energy sources such as hydrogen and biomass are still in early stages, and so, the sustainability in the production and use of most of these fuels on as large a scale as coal is yet to be proven.

1.1.2. Environmental Sustainability Evaluation in Coal Mining. Despite the importance of coal, there have been increasing concerns over environmental problems associated with the extraction and use of coal, as knowledge and understanding of impacts of products and processes on the environment have grown. The environmental impacts of coal include, among others, the generation of dust and noise from mining equipment, and the emissions of criteria air pollutants (from energy use in the mining operations and the use of coal) that cause acidification, photochemical oxidation and that have toxic properties. Coal is also associated with greenhouse gas emissions that are responsible for climate change. These include coalbed methane from coal strata and carbon dioxide (CO₂) and nitrous oxide (N₂O) from energy use in the mining operations as well as from the use of coal in electricity generation and in other industrial processes. Coal mining causes disturbance of large areas of land and associated habitats; pollution of water sources from acid mine drainage generation and depletion of fresh water sources in arid regions.

With increasing environmental awareness, more and more industries and businesses are trying to make assessments of the how their activities affect the environment in order to identify appropriate corrective measures to improve environmental sustainability of their processes and products. Progressive mining companies with foresight have recognized that environmental sustainability initiatives do not only help keep them in compliance, but they also aid in keeping them competitive by improving management, environmental performance and efficiency of their operations, as well as in enhancing their public image.

Table 1.1 shows the results of a survey of the websites for US coal mining companies carried out to assess how the US coal mining industry handles environmental sustainability reporting. The results revealed huge disparities in the reporting of environmental sustainability across the industry. Only a small number of companies, mainly large international mining corporations, have clearly defined performance targets, quantitative data for performance assessment and evidence of use of elaborate sustainability evaluation and reporting tools. For the majority of companies, there is limited information on environmental sustainability performance. Mostly the websites carry mission statements about environmental sustainability, and anecdotes about projects done or intended to be done, especially reclamation work, and awards received for reclamation activities. There are no indications of environmental performance targets, nor performance figures. For a lot of them, especially, the small scale operations, they do not have websites to communicate information to the public.

The variability in the quality of reporting of environmental sustainability information in the US coal mining industry is a good indicator of the different levels to which sustainability has been adopted in the industry. Some shortfalls in the quality of reporting observed may be attributed to the limitations of the tools used in environmental systems analysis. There are various tools available for evaluation of environmental performance. These include, Environmental Impact Assessment; Ecological Risk Assessment (ERA); Ecological footprint and Material Flow Analysis (MFA). However, each evaluation tool typically has a unique operating scope, strengths and weaknesses, which would dictate the kind of information that could be obtained from its use.

There are a variety of reasons that lead to disparities in environmental performance monitoring and reporting in the coal mining industry. One of the problems is the inconsistent government requirements for permitting of coal mining operations and for reporting of environmental performance data. Due to these inconsistencies, opportunities for improvement of sustainability of coal mining could be missed. One inconsistency lies in the fact that coal mining permit applications for sites outside of Federal and Indian lands are not typically required to be accompanied by an Environmental Impact Assessment. Given that there are lots of coal mining properties outside Federal and Indian lands, a good number of coal mining projects are not required

Table 1.1. Web survey results on environmental sustainability reporting in the US coal mining industry

(Note: No official contact was made with the companies in compiling the results)

		2008 Production (10 ⁶ tons)	Website available	Website section on environment	Environmental sustainability report	EMS/Reporting guidelines	Env. performance evaluation tool	Env sustainability targets	GHG emissions data	Criteria air pollutants data	Water quality data	Water use data	Solid waste data	Energy use data	Land disturbance & reclamation data	
1	Peabody Energy Corp.	200		✓	✓	✓	X	X	X	X	X	X	X	X	X	✓
2	Cloud Peak Energy ^{†‡}	141	✓	✓	✓	✓	✓	✓	✓	✓	✓	✓	✓	✓	✓	✓
3	Arch Coal Inc.	134	✓	✓	X	X	X	X	X	X	X	X	X	X	X	X
4	Foundation Coal Corp.	69	✓	✓	X	X	X	X	X	X	X	X	X	X	X	X
5	Consol Energy Inc.	64	✓	✓	X	X	X	X	X	X	X	X	X	X	X	X
6	Massey Energy Co.	40	✓	✓	X	✓	X	X	X	X	X	X	X	X	X	X
7	Patriot Coal Corp.	33	✓	✓	X	X	X	X	X	X	X	X	X	X	X	X
8	NACCO Industries Inc.	30	✓	✓	X	X	X	X	X	X	X	X	X	X	X	X
9	Westmoreland Coal Co.	29	✓	✓	X	X	X	X	X	X	X	X	X	X	X	✓
10	Peter Kiewit Sons Inc.	28	✓	✓	X	✓	X	X	X	X	X	X	X	X	X	X
11	Alliance Resources Partner	26	✓	X	X	X	X	X	X	X	X	X	X	X	X	X
12	Murray Energy Corp.	26	✓	X	X	X	X	X	X	X	X	X	X	X	X	X
13	Energy Future Holdings	23	✓	✓	X	X	X	✓	X	X	X	X	X	X	X	X
14	Alpha Natural Resources	21	✓	✓	X	X	X	X	X	X	X	X	X	X	X	X
15	International Coal Group	18	✓	✓	X	X	X	X	X	X	X	X	X	X	X	X
16	BHP Billiton Ltd ^{†‡}	16	✓	✓	✓	✓	✓	✓	✓	✓	✓	✓	✓	✓	✓	✓
17	Chevron [†]	11	✓	✓	✓	✓	✓	✓	✓	✓	✓	✓	✓	✓	✓	X
18	PacifiCorp	11	✓	✓	X	X	X	X	X	X	X	X	X	X	X	X
19	James River Coal Co.	11	✓	X	X	X	X	X	X	X	X	X	X	X	X	X
20	Trinity Coal Corp.	11	X	-	-	-	-	-	-	-	-	-	-	-	-	-
21	Walter Industries	7.5	✓	X	X	X	X	X	X	X	X	X	X	X	X	X
22	Cline Group	6.1	X	-	-	-	-	-	-	-	-	-	-	-	-	-
23	Black Hills Corp.	6.0	✓	✓	X	X	X	X	X	X	X	X	X	X	X	X
24	Energy Coal Resources Inc.	6.0	X	-	-	-	-	-	-	-	-	-	-	-	-	-
25	Western Fuels Association	5.3	✓	X	X	X	X	X	X	X	X	X	X	X	X	X

✓ Available

X Not available

- Not applicable

to undergo such assessments. For some mine operators, the interest on environmental issues only goes as far as addressing them in order to meet the minimum requirements for compliance. Such mine operators are not likely to conduct environmental impact assessments or any other studies to evaluate the performance of their operations, when it is not required of them by law.

Another pertinent example of how government rules and requirements can influence how companies act on sustainability issues can be drawn from guidelines for DOE's Voluntary Reporting of Greenhouse Gases Program and the recently introduced EPA's Mandatory Reporting of Greenhouse Gases Rule. In the voluntary reporting program, a threshold of 10,000 metric tons of CO₂-equivalent emissions per year has been set to decide which operations are large emitters and therefore need to report their emissions, while the EPA's mandatory reporting rule stipulates 25,000 metric tons CO₂-equivalent or more per year of GHG emissions as a qualifier for reporting. First, the thresholds leave out the many small scale operators, and may provide a false sense of security. The second drawback in the reporting requirements is that they focus only on emissions over a time period, rather than emissions per unit of product. The main flaw in this is that the many small operations left out from reporting typically have lower performance records on the environmental issues compared to the large scale operations that also have the benefits of economies of scale and thus superior production efficiency and emissions. In general, large scale operations are run by big corporations that often have effective sustainability initiatives and perform better on environmental sustainability.

1.1.3. LCA in Evaluation of Mining Products. Life cycle assessment (LCA) of a product or service is the assessment of environmental burdens of a product or service across its life cycle (Bauman and Tillman, 2004). This a comprehensive tool for quantifying and interpreting environmental impacts of a product or service from the cradle to the grave. However, depending on the nature and intended purpose of an LCA study, the boundaries of the system under study may be modified appropriately resulting in either a cradle-to-gate or gate-to-gate assessment.

The LCA technique has been used to assess environmental impacts associated with various products. Unfortunately, its use in assessing mining products and processes

has been limited, as evidenced by limited published literature on LCA applications in mining. This situation is particularly true for coal mining. The DOE's National Renewable Energy Laboratory (NREL) has an LCA database (www.nrel.gov/lci/database) for various products. The database has comprehensive data on coal use, in electricity generation, but the data for coal mining products is limited and a number of important environmental flows are missing.

Coal is linked directly or indirectly to a lot of industrial processes which may be studied through LCA. Coal is important for electricity which in turn is associated with a lot of industrial processes. These links make comprehensive life cycle inventory (LCI) information on coal crucial for LCA in general. Often, life cycle inventory data on extraction processes for electric generation fuels such as coal is non-existent and this affects the completeness of LCIs for electricity and other industrial processes. Kim and Dale (2005), in their compilation of the life-cycle inventory of the United States Electric System, cited a lack of data on upstream processes such as coal extraction as a source of uncertainty in the inventory data. Databases such as the Emissions and Generation Resource Integrated Database (eGRID) developed by EPA contain comprehensive information on the US electricity system, but they provide only limited gate-to-gate emissions, because of missing data for upstream processes such as coal extraction (Kim and Dale, 2005). The lack of data on life cycle emissions from coal extraction could be linked to the general lack of data on US mining industry for energy use, mining processes, equipment types and fuel types (DOE, 2007). The general unwillingness to share data on processes and performance, as well as the limited life-cycle thinking in the mining industry could be cited as the main reasons for the lag in LCA applications in coal mining.

LCA studies of coal mining can help fill LCI data gaps, and perhaps generate data that could be helpful to the coal mining industry as whole. LCA data can help in pinpointing processes from which the coal mining industry can potentially reap benefits of significant reductions in life cycle impacts of coal. LCA can be used to complement other environmental systems analysis tools and aid in environmental sustainability reporting for coal mining businesses.

1.2. STATEMENT OF PROBLEM

Given the wide range of concerns over environmental burdens associated with coal, concerted efforts to ensure sustainable coal extraction and use are necessary. This calls for the employment of all the necessary environmental sustainability tools to evaluate and identify all potential areas for improvement.

While there is a general shift by the coal mining industry and the mining industry in general towards embracing environmental sustainability, there are still some shortfalls in the adoption of the concept. There is still limited use of environmental sustainability evaluation tools in the coal mining industry, and this may imply limited knowledge and awareness of issues of sustainability. In cases where environmental sustainability analysis tools are used, the inherent limitations in the scope of analysis that can be covered by particular tools, and the form in which the data is presented, affects the quality and effectiveness of sustainability reporting (see Table 1.1).

Even though the life cycle assessment framework currently is believed to address mining issues poorly (Lindeijer, 2005), when adapted appropriately, the technique can provide valuable information about mining processes. Life cycle assessment provides unique information due to its quantitative and analytical character, and the fact that it is a holistic approach that assesses environmental flows through the life cycle of a product. The holistic approach inherent in the tool enables all impacts to be brought together into one framework, irrespective of where they occur, thereby ensuring that transfers in emissions and impacts to different life cycle stages, locations, or different media, as a result of changes in the processes, are not overlooked.

Some evaluation tools tend to measure environmental flows on the basis of time (e.g. annual basis), which often gives a distorted perception that the bigger the scale of operation is, the bigger the environmental flows and impacts. Such evaluations fail to communicate the fact that small scale operations while appearing to have lower impacts actually have poor efficiencies, and therefore are not the best way to ensure sustainability in the long term.

In LCA, environmental impacts are assessed on the basis of a functional unit of product or service. For example, in the case of coal, a functional unit may be based on

mass (e.g. 1 tonne) or energy content (1 Megajoule). Such a metric gives a better picture of performance in terms of intensities of material and energy inputs, and environmental flows. Therefore, it is important to improve awareness of and encourage use of systematic and comprehensive sustainability analysis tools such as LCA, which can provide valuable information to industry, government and the public.

1.3. OBJECTIVES AND SCOPE OF RESEARCH

The objective of this research work was to estimate cradle-to-gate life-cycle impacts of surface coal mining using the general principles of ISO 14040-49 series of standards for life-cycle assessment and adapting them to the peculiar situation of coal mining. The study was aimed at giving an understanding of the contributions of the mining stage and processes to the overall impacts of coal, using data from five strip mining operations in the US.

In this work, water use, land use, energy use, abiotic resource depletion for energy sources and climate change impacts were assessed for each mine. The mines' performances were compared on the basis of the impacts. While there are other impact categories such as, acidification, eutrophication, human toxicity, ecotoxicity, and photochemical oxidation, that are important and relevant to coal mining, the five were chosen because of their connection to the peculiarity of coal. Processes downstream of mining have not been included in this study because a lot of LCA work has been done in those areas as evidenced by the existence of comprehensive databases on coal use, especially in electricity generation. The scope of the work covers processes of the mine life stages and impacts as shown in Figure 1.1.

A sensitivity analysis was conducted to evaluate the implications of data uncertainty on the overall results. Dominant sources of impacts that deserve further attention were identified and treated comprehensively. Recommendations on addressing potential impacts were made and finally, data quality and uncertainty issues were assessed qualitatively.

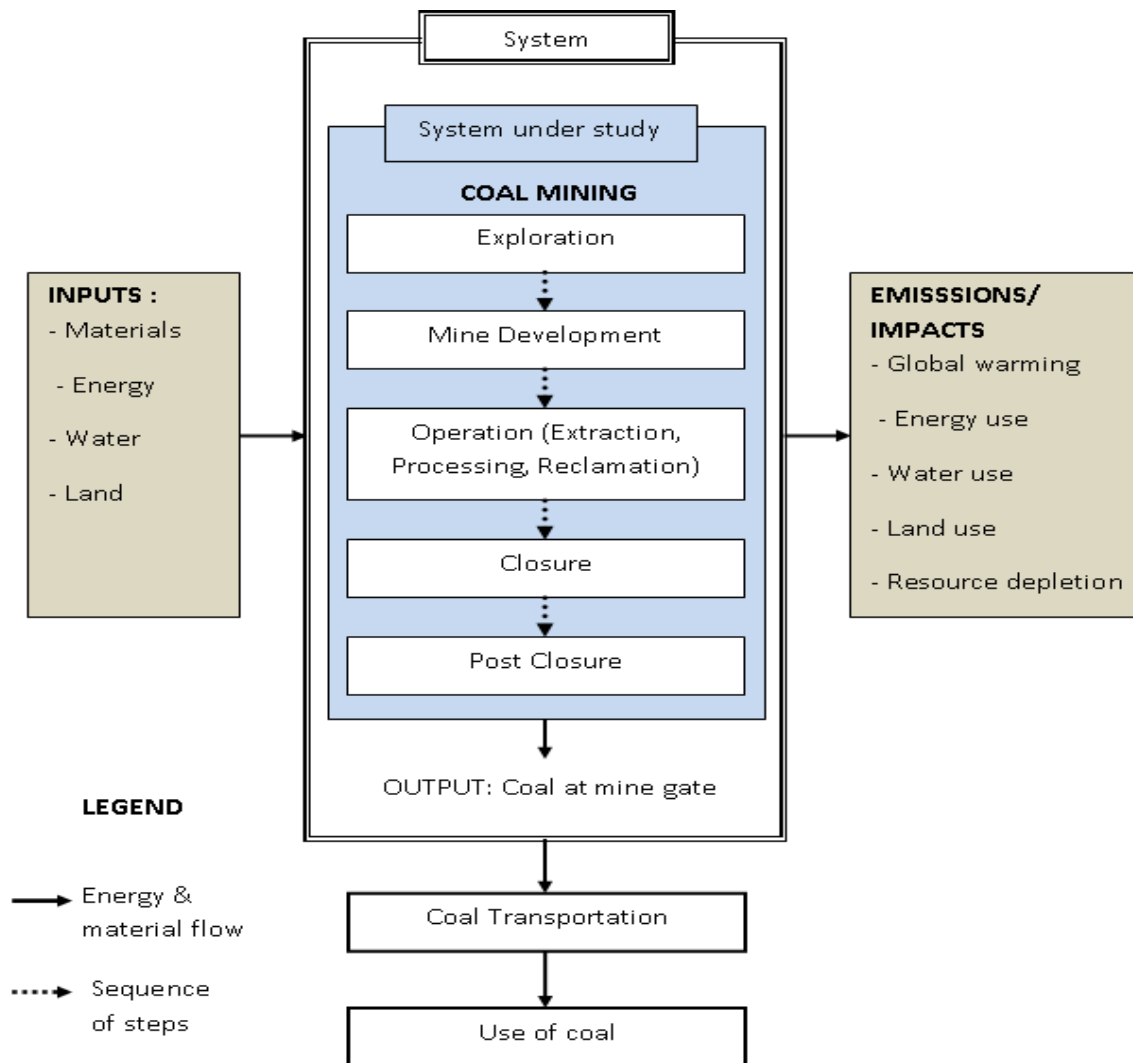

Figure 1.1. Processes in the cradle-to-gate life cycle assessment of coal

1.4. RATIONALE FOR STUDY

This study was done to provide diversity in environmental sustainability analysis tools used in the coal mining industry and in mining in general. Given that all environmental sustainability evaluation tools have their shortfalls, this study was intended to provide a life-cycle perspective in understanding environmental burdens associated with coal mining processes. The study was meant to encourage use of LCA as a complement to other tools for evaluating environmental impacts of coal mining.

It was envisaged that this study would provide a baseline on which the coal mining industry could build on to improve their environmental management systems as well as sustainability reporting. The research work gives an appreciation of the unique information that can be obtained from LCA studies, and which can inform the public, industry and government on the true nature and extent of impacts coal mining processes. The results of this work provide information that can influence policy making decisions, either at government level or at individual company level, regarding areas or processes where greater controls of impacts are necessary. This study was intended to contribute data towards LCI for coal mining, which so far is very limited. The coal mining industry and LCA practitioners can build on the results of this study and conduct similar LCA studies to further enhance data quality necessary for addressing data gaps in LCIs for coal and other processes and products that are linked to coal.

1.5. METHODOLOGY

The research involved performing a cradle-to-gate life-cycle assessment of surface coal mining employing the general principles of the ISO 14040-49 series of standards and adapting them to the unique situation of coal mining. Data was sourced from mine permit applications, air permits, published literature, government reports, and other publicly available documents. The LCA steps followed include:

- a. Goal and scope definition.
- b. Inventory analysis.
- c. Impact assessment.
- d. Reporting and recommendations for improvement.

1.6. STRUCTURE OF THESIS

A review of literature is covered under Chapter 2, which has been broken down into four main subsections covering environmental sustainability in mining, tools for environmental systems performance analysis, overview of LCA framework, and

applications of LCA in mining and challenges. Chapter 3 presents the goal and scope definition for the LCA study, and life cycle inventory analysis is covered under Chapter 4. The results of the impact assessment are presented and discussed in Chapter 5, and finally, conclusions and recommendations for future work are covered under Chapter 6.

2. LITERATURE SURVEY

This chapter covers a review of literature relevant to research on the application of LCA in coal mining. The literature review covers environmental impacts of coal; environmental sustainability in mining and coal; environmental assessment tools; overview of life cycle assessment (LCA) framework; applications of LCA to mining and coal, as well as challenges in applying LCA to coal mining.

2.1. ENVIRONMENTAL IMPACTS OF COAL

Despite the contribution of coal to energy security and to the social and economic upliftment of communities, it is faced with challenges of environmental issues (World Coal Institute, 2005; Chihn, Gheewala and Bonnet, 2007). There is increasing awareness of and concerns over the environmental impacts of coal (Hansen, Notten and Petrie, 2002). Environmental impacts of coal can be significant locally or regionally (Worrall, et al. 2009), or even globally, as in the case of climate change impacts from greenhouse gases (GHG) emissions. Environmental impacts of note associated with coal include those from coal mining and from the use of coal in electricity generation and in other industrial processes. Coal mining activities can have severe and lasting effects on the natural environment (Worrall et al., 2009). Coal use in electricity generation releases pollutants whose impacts on the environment and human health are the primary concern over its use as an energy source (Babbitt and Lindner, 2005). Environmental problem of coal have sparked calls to increasingly shift towards renewable energy sources for electricity generation (Froese et al., 2010).

2.1.1. Climate Change. The US Department of Energy's (DOE) analysis of energy use and associated greenhouse gas (GHG) emissions for the US mining industry estimates that coal mining emits about 29.4 million tons of CO₂-equivalent of greenhouse gases per year (DOE, 2007), which contribute to climate change. The GHG emissions associated with coal include methane from coal strata, and carbon dioxide and nitrous oxide from the use of fuels in coal mining operations, as well as in the use of coal in

electricity generation and other industrial processes, such as steel production and cement manufacture (World Coal Institute, 2005).

Concerns over GHG emissions from anthropogenic activities have led to international initiatives such as the 1997 Kyoto Protocol to the United Nations Framework Convention on Climate Change, which aims to bind big economies to stabilize GHG emissions (UN, 1998). In June 2009, the US House of Representatives passed the American Clean Energy and Security Act (H.R. 2454), otherwise known as the Waxman-Markley comprehensive energy bill. The bill includes an economy-wide cap-and-trade plan on greenhouse gas emissions in order to reduce climate change (CBO, 2009). This bill has stirred concerns and debate on its implication for the future of the US coal mining industry.

While most of the GHG emissions associated with coal are from the use stage, e.g. electricity generation (Hendrickson, Lave and Matthews, 2006), it is crucial to look at the whole life-cycle of coal, including the mining stage, to identify any opportunity for reducing these emissions. To meet emission cuts, such as those set out in the Kyoto Protocol (UN, 1998), it is imperative to pursue a comprehensive, all encompassing, strategy. Rather than focusing only on a few operations that are regarded as big GHG emitters, it may be helpful to look at all emitters since the contributions from the many small emitters may be significant.

2.1.2. Energy Use. Efficient use of energy resources is one area that is crucial to the sustainability of coal mining and mining in general. The energy used to mine and process minerals is a growing concern given the global concerns over climate change impacts associated with energy use (Basu and Carabias-Hütter, 2004). Energy sources, including electricity and diesel, are important inputs to mining (Bogunovic and Kecojevic, 2009) and make up the highest component of mining costs (Cheskidov, Kortelev, Aleksandrov and Il'bul'din, 2004). The U.S. mining industry (excluding oil & gas) consumes approximately 1,246 Trillion Btu of energy per year (DOE, 2007), and this represents about 1.3 percent of the 99 Quadrillion Btu total energy consumed in the US, annually (EIA, 2009d).

Energy use has always been accounted for in life cycle assessment (Baumann and Tillman, 2004), but often it has only been addressed to the point of inventory compilation

and determining environmental flows associated with it, and not necessarily as an impact category. It is essential to focus on energy use as an impact so that issues of energy efficiency, especially when dealing with processes whose product is an energy source, as in the case of coal mining, can be given due attention. Given that coal mining processes involve using fossil fuels, either directly or indirectly through electricity, whose supply is not infinite, it is important to understand the energy profile of the coal mining industry.

2.1.3. Resources Depletion For Fossil Fuels. At the current extraction rates, it is estimated that the US recoverable coal reserves could last for about 230 years (EIA, 2009c). US reserves for crude oil and natural gas are expected to last for even shorter periods: 24 years for crude and 70 years for natural gas at 2007 domestic consumption levels (EIA, 2009c). Management of non-renewable resources has become a key issue in the debate on sustainability (Worrall et al., 2009), and so, resource depletion is one of the emerging impact categories in evaluating products (Morris, 2005). Since fossil fuels are non-renewable resources, it is important to look at their depletion implications of extracting coal by certain mining systems. This impact category is particularly relevant to fossil fuels because, unlike metal minerals, after extraction they do not accumulate in the technosphere where they could be recyclable (Morris, 2005): once used, they are destroyed.

2.1.4. Land Disturbance. Coal mining, particularly surface coal mining, affects large areas of land and habitats (Canals et al, 2007; Worrall et al., 2009), and this is one of the reasons often cited in opposition to coal mining by environmental pressure groups and communities. The opposition to surface coal mining projects sometimes emanates from a lack of appreciation of some positive aspects that are unique to surface coal mining nowadays. Unlike in the cases of surface metal and non-metal mining operations, the land impacted by surface coal mining is typically reclaimed contemporaneously with mining to allow for post-mining uses that are the same as pre-mining uses or better, as required by the regulations of the Surface Mining Control and Reclamation Act (SMCRA) of 1977.

Land use impacts are seldom included in environmental assessments of products (Canals et al., 2007). However, land use impacts in mining are believed to be important and the dominant contributor to changes on global biodiversity, so that leaving them out

of any impact assessment is a flaw (Lindeijer, 2005; Bourassa, 2005). The large surface area disturbances characteristic of surface coal mining makes this impact even more relevant and important to this type of mining.

2.1.5. Water Use. The potential for water depletion by coal mining processes is an important issue, particularly in arid areas (Baur and Zapp, 2005; Luba et al., 2006; Mangena and Brent, 2006). Coal mining involves the use of water for dust allaying on haul roads, coal washing, and coal transportation by hydraulic transportation in some cases. The quantity of water used in mining can be high depending on processes involved (Mangena and Brent, 2006). The potential for water depletion in some areas makes it vital to assess the water use impacts for coal mining in such areas, so as to enable development of effective strategies for water use management.

2.1.6. Water Quality. Processes in coal mining and coal use (e.g. electricity generation) can release effluents that can impact water quality. The formation of acid mine drainage (AMD) is one of the major environmental problems facing the coal mining industry (EPA, 1994; Mangena and Brent, 2006; Chihn et al., 2007; Worrall et al., 2009). AMD forms from the oxidation of sulfide minerals in the presence of water, resulting in effluent that is acidic and rich in metal and sulfate ions (Jage, Zipper and Noble, 2001). The resulting drainage affects the quality of water and aquatic ecosystems around mines (Cravotta, 2003). Coal mines typically have this problem because of presence of sulfide minerals such as pyrite and marcasite, which are usually associated with coal strata (Jage et al., 2001). AMD generation during mining sometimes continues through the post mining stage if not adequately addressed during reclamation. According to Kaas and Parr (1992) and EPA (1994), it is estimated that in the Appalachia, between 7,000 and 8,000 kilometers of streams were polluted by AMD from coal mines, mostly abandoned ones.

The regulations of the Surface Mining Control and Reclamation Act (SMCRA) of 1977 require coal mine operators to meet land reclamation standards that aim to minimize generation of acid mine drainage. The water quality standards found in the Clean Water Act of 1972, which regulates effluent releases into US waters, place a requirement on coal mine operators to treat water impacted by AMD to acceptable quality levels before it is discharged into water courses.

2.1.7. Acidification, Photochemical Oxidation and Toxicity. Coal mining activities release dust particulates and various gaseous pollutants from the use of diesel and other energy sources (Chinh et al, 2009). The burning of coal in electricity generation stations also results in emissions of various pollutants into the air (Babbitt and Lindner, 2005). Some of the gases (e.g. oxides of sulfur and nitrogen) can result in impacts such as acidification and photochemical oxidation. Trace elements, such as mercury, selenium and arsenic released from the burning of coal, can lead to human toxicity and ecotoxicity (World Coal Institute, 2005).

2.1.8. Solid Waste. Coal mining generates significant quantities solid waste (Worrall et al., 2009), and this may be in the form of overburden material and gob material from the coal washing processes. However, unlike in other surface mining operations, coal mining waste is useful as backfill in the reclamation of mined out areas (McCarter, 1992), and usually, the waste from coal washing is buried under spoils in mined out pits. The use of coal in electricity generation also produces solid waste in the form of Coal Combustion Products (CCPs), such as fly ash, bottom ash and boiler slag and flue gas desulfurization material (World Coal Institute, 2005). While CCPs may have beneficial uses, most of the CPPs generated cannot be put to use, and therefore they pose problems of waste management (Babbitt and Lindner, 2008).

2.2. ENVIRONMENTAL SUSTAINABILITY IN MINING AND COAL

The World Commission on Environment and Development (WCED, 1987) defines sustainable development as “the ability of current generations to meet their needs without compromising the ability of future generations to meet their own needs.” The approach to defining sustainability varies considerably among different stakeholders (Spitzley and Tolle, 2004; Manderson, 2006; Mudd, 2009; Muga, 2009). The definition of sustainability depends on whether the views are from business leaders, scientists, civic groups or government (Spitzley and Tolle, 2004; and Mudd, 2009). However, it is generally agreed that sustainability requires a balanced implementation of the social, economic and environmental objectives (Basu and Carabias-Hütter, 2004; Muga, 2009; Finnveden, et al., 2009).

In mining, balancing the different aspects of sustainability is extremely complex because of the wide group of stakeholder requirements that have to be satisfied (Basu and Carabias-Hütter, 2004). The different views on what sustainability entails have led to disparities in how elements of sustainability are adopted and implemented (Bond et al., 2010). von Below (1993) characterized the disparate views on sustainability as applied to mining by suggesting that the level of concern for the environment is a function of the level of welfare of a community. Rees (1992) cites the example that, when considering trade-offs between economic growth and environmental quality, developing nations are likely to emphasize on economic aspects, because their main concern is breaking the cycle of debilitating poverty. Thus, the views on sustainability of a mining project at a local level may not be in line, or may even clash, with those at a regional or international level.

The mining industry is increasingly embracing sustainability and adopting performance indicators for reporting sustainability performance (Basu and Carabias-Hütter, 2004). While some companies only go as far as the minimum requirements for regulatory compliance (McLellan et al., 2009), others have found it advantageous to look beyond compliance (EPA, 2006), and they have incorporated sustainability into their management systems and employ corporate sustainability reporting, environmental management systems, as well as environmental performance analysis tools to improve their image and stay competitive.

Perez and Sanchez (2009) and Matthews et al. (2004) evaluated how the standard of sustainability reporting stands in the mining industry by reviewing sustainability reports for major mining corporations. They compared the reports against international reporting guidelines, including those of the Global Reporting Initiative (GRI), looking at the number of indicator categories covered, and the quality of information for each of the covered indicators. The results of the study by Matthews et al. (2004) are illustrated in Figure 2.1.

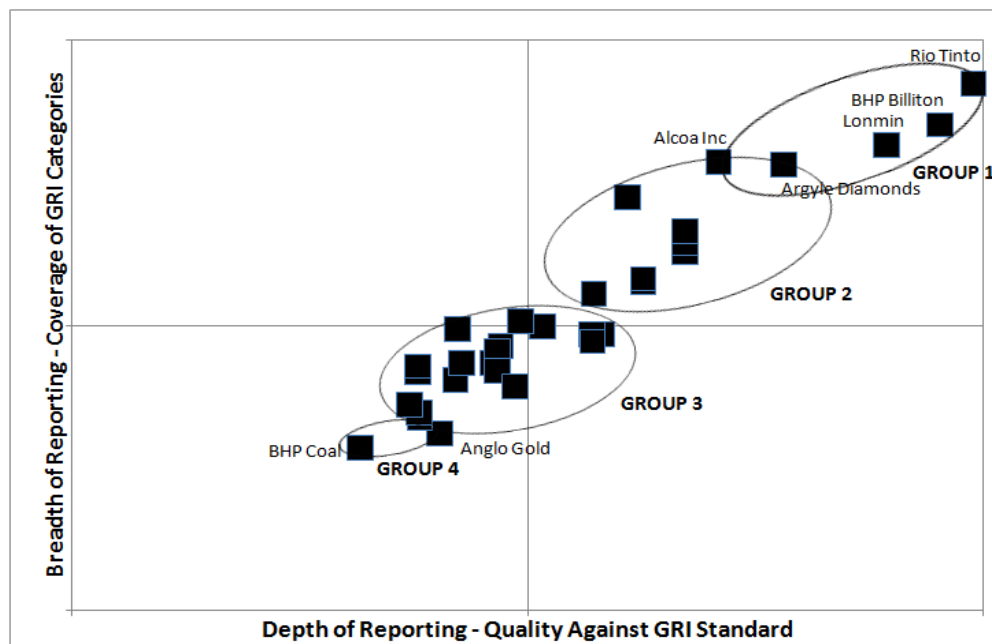

Figure 2.1. Standard of sustainability reporting in the mining industry
(Adapted from Matthews et al., 2004)

Both studies note that performance on sustainability evaluation and reporting varies widely in the mining industry. In addition, environmental performance is the one that has greatest variability in the reporting of indicators (Perez and Sanchez, 2009), as well as the worst reporting (Matthews et al., (2004), compared to sustainability indicators for economic and social aspects. Matthews et al. (2004) concluded that companies which report on sustainability fall into four distinct groups, and that there is a fifth group comprising companies that do not report anything that is relevant to sustainability:

- Group 1: These are the influencers who are actively leading and setting the industry agenda, and they use sustainability to differentiate themselves from competitors.
- Group 2: Companies that are rapidly improving their reporting performance, following on the footsteps of the first group.
- Group 3: Companies focused on risk reduction activities.

- Group 4: Companies that are still coming to grips with sustainability and have no holistic approach, but rather focus on specific, narrow areas.

The US coal mining industry has only a few big, multi-national corporations, and most of the players in the industry are small operators, who would most likely fall under the fifth category as defined by Matthews and others (see Table 1.1).

The major challenge facing coal mining is environmental sustainability (Mangena and Brent, 2006). Opposition to coal mining has for the most part emanated from issues of environmental damage, including among others, destruction of vast areas of forests and ecosystems due to surface mining, acid mine drainage generation and pollution of water sources, as well as acidification and climate change impacts from mining and use of coal.

In the US, the modern era of environmental concerns emerged in the 1960s, driven by domestic concerns over local air and water pollution and coal strip-mining issues, among many others (Speth, 2002). These concerns led to the development of the National Environmental Policy Act (NEPA) in 1969, from which several pieces of legislation have been enacted to protect the environment. The promulgation of different pieces of environmental protection legislation has shaken the US coal mining industry over the years. For instance, the limits on sulfur dioxide (SO₂) emissions mandated by the Clean Air Act of 1970 forced some coal fired electric generation plants to switch to low sulfur coal from the Western US or to alternative fuels (Rau, 1987), and the result was that many coal mines in the Eastern US had to close down (Kral, 1993). The recent passing of the American Clean Energy and Security Act of 2009 (H.R. 2454) by the House of Representatives in June 2009, aimed at reducing greenhouse-gas emissions in order to combat climate change (CBO, 2009), sparked a big debate and uncertainty about the future of coal (Storm, 2009; Carpenter and Hairfield, 2010).

The impact of mining on the environment can resonate for many years (Mudd, 2009; Worrall et al., 2009), and this makes environmental sustainability crucial. The environmental component of sustainability in coal mining projects deserves attention, just like economic and social aspects. Awareness and scientific knowledge of environmental

effects of processes and products are continually increasing (Muga, 2009), and this results in new impacts that have to be taken into account by the coal mining industry. The newly discovered impacts and subsequent regulations to address them, necessitate that the coal mining industry should continually assess and improve the resources needed to address environmental problems. This may involve adopting new environmental performance measurement tools to enable the industry to address the environmental impacts which otherwise cannot be sufficiently dealt with by other tools.

2.3. ENVIRONMENTAL ASSESSMENT TOOLS

Increasing interest in environmental issues has put pressure on industries to develop more environmentally friendly processes and products (Gäbel and Tillman, 2005). In order to deal with environmental problems at their sites, companies, including mining companies, are increasingly adopting environmental management systems such as the ISO 14001 - Environmental Management System (Petrie et al., 2000). The key features of environmental management systems (EMS) are the requirement for evaluating and reporting performance, as well as to continually improve performance.

There are a number of factors that can contribute to disparities in environmental sustainability performance for coal mining companies. These may include, local legal requirements; ownership (whether private or public); level of awareness of environmental issues and management's attitude towards environmental issues; size of company and resources available. In order to achieve environmental sustainability, there is need to define its components in measurable terms (Rebitzer et al., 2004), and to set targets against which performance can be measured (Hales and Prescott-Allen, 2002). For companies that collect environmental performance data, the shortcomings in their reporting could be due to limitations of the environmental evaluation tools employed. Without proper assessment methodology that uses quantifiable measures, there is a risk of failing to achieve intended results, or at worst, getting unintended results which may turn out to be worse (Hales and Prescott-Allen, 2002).

There are various tools for assessing the environmental performance of systems, and these include, Environmental Impact Assessment, Ecological Footprint, Risk

Assessment, Ecological Risk Assessment, Material Flow Analysis and Life Cycle Assessment (Baumann and Tillman, 2004). Each of these tools has a unique scope, strengths, and weaknesses, which determine the form of data and level of detail in the data that is used for sustainability reporting, and hence the quality of reporting.

2.3.1. Environmental Impact Assessment. The International Association for Impact Assessment (IAIA) defines Environmental Impact Assessment as “the process of identifying, predicting, evaluating and mitigating the biophysical, social, and other relevant effects of development proposals prior to making major decisions and commitments.” Environmental Impact Assessment is a tool that attempts to balance economic, ecological and social aspects of projects and it is used for environmental planning and decision making for implementation of projects (Bond et al., 2010). It is a procedural tool that is prescribed by law, and its key aspects are detailed descriptions of the anticipated local environmental impacts and public participation in the process (Baumann and Tillman, 2004). In the US, under NEPA, Environmental Impact Statements (EIS) are required for federally supported developments. Coal mining projects proposed in Federal lands or Indian Lands typically are subject to the EIS requirement.

The Environmental Impact Assessment approach recognizes that each site is unique, with its own set of issues, and so, the results of an Environmental Impact Assessment are specific to an operation in a specific location setting (McLellan et al., 2009). In mining, it is important to recognize site specific differences as this allows for tailored designs to effectively address the concerned problems at particular sites (van Zyl, 2005; McLellan et al., 2009). However, the approach of dealing only with impacts at the site of the operation presents a limitation in that an Environmental Impact Assessment cannot give a full picture of the overall environmental impacts of a product beyond the production phase.

The Environmental Impact Assessment’s downside is that it is not likely to identify the transfer of environmental problems outside the boundaries of the site due to choices made in process design. In fact, choosing alternatives that shift environmental impacts beyond the borders of the process site tends to be tolerated in Environmental Impact Assessment. For instance, when comparing the options of electricity generation in a mining site and electricity from the grid, there is likely to be preference for

connecting to electricity from the grid, because the emissions would be off site, even though the grid electricity may be generated from higher impact energy sources.

2.3.2. Ecological Footprint. The concept of Ecological Footprint was conceived in 1990 by Mathis Wackernagel and William Rees (Global Footprint Network, 2009). It is based on the assumption that, for a given area, there is a maximum rate of resource consumption and waste discharge that can be sustained indefinitely without progressively impairing the functional integrity and productivity of the ecosystem (Rees, 1992). The Ecological Footprint is a measure of humanity's demand on nature, and it evaluates how much land and water area a human population requires to produce the resources it consumes and to absorb its wastes using prevailing technology (Global Footprint Network, 2009). This tool has very little use in evaluation of specific products, services or operations (Spitzley and Tolle, 2004). The scope of this tool is limited to evaluating the carrying capacity of land (area metric), and so it does not cover a lot of impact categories that can be evaluated by other assessment tools such as LCA.

2.3.3. Risk Assessment. Risk assessment is the process of assessing the probability of occurrence of adverse events as well as their potential consequences (Jones, 2001). In the context of environmental performance evaluation of products or processes, risk assessment typically relates to toxic effects of chemicals, and it characterizes them with respect to human health and the environment (SETAC, 1997).

Risk assessment aims to quantify actual risk, and therefore it requires specific information on the conditions of a given population, and this makes the tool more specific to a site at a given time (Olsen et al., 2001). The downside to application of risk assessment in evaluating products lies in the fact that risk assessments are narrowly focused in their scope as they deal with toxicological impacts at a specific location. Risk assessment is more suited for the evaluation of a facility that makes a product, rather than for a product over its life cycle.

2.3.4. Ecological Risk Assessment. An Ecological Risk Assessment (ERA) determines the nature and likelihood of effects of human activities on animals, plants and the environment (SETAC, 1997). The environmental value (e.g. species or habitat type) that is to be protected is identified together with its vulnerability, the contaminants present and their ecotoxicity characteristics, then, risk is characterized by integrating

exposure and stressor-response profiles (SETAC, 1997; EPA, 1998). Ecological risk assessments provide information about the potential adverse effects of different management decisions, and the EPA uses ERAs to support management actions, including regulation of hazardous wastes and industrial chemicals (EPA, 2008). ERA is useful for addressing site specific impacts on biodiversity, but its usefulness in evaluating a product over its life cycle is limited.

2.3.5. Material Flow Accounting. Material Flow Accounting (MFA) or Material Flow Analysis is used to analyze and describe flows of a particular material within a region (e.g. a nation or a municipality), an industrial sector or an organization (Baumann and Tillman, 2004; De Marco et al., 2009). In the context of environmental evaluation of products, businesses can use MFA to assess resource use intensities in order to improve efficiencies in the use of materials. However, this kind of assessment would be limited to the production stage in the life cycle of a product.

MFA can be used to evaluate material flows between different economic sectors at a national level, and these flows, together with economic accounting models, can be used to develop economic input–output LCA models (De Marco et al., 2009). An economic input-output LCA (EIO-LCA) model provides a faster and cheaper way to conduct LCAs, but it can only give rough estimates for some products (Huijbregts et al., 2001; Hendrickson et al., 2006). Thus, the EIO-LCA models do not give detailed data for individual unit processes in the manufacture of a product, and as such, they cannot be useful where accuracy is critical, such as when comparing environmental performances of different products or individual unit processes for a product.

2.4. LIFE CYCLE ASSESSMENT FRAMEWORK

The ISO 14040 standard defines life cycle assessment (LCA) as the compilation and evaluation of the material and energy flows, and of the potential environmental impacts of the life cycle of a product (ISO, 1997). Thus, LCA assesses the potential environmental impacts and resources used for a product, from the point of raw material acquisition, through production of product parts and the product itself, and the use of the product, to ultimate disposal of product and its waste management. A characteristic

central to LCA is its holistic approach (Guinée, 2002; Muga, 2009), in that it covers potential environmental impacts through all the stages in the life cycle of a product. Figure 2.2 illustrates a general life cycle assessment model.

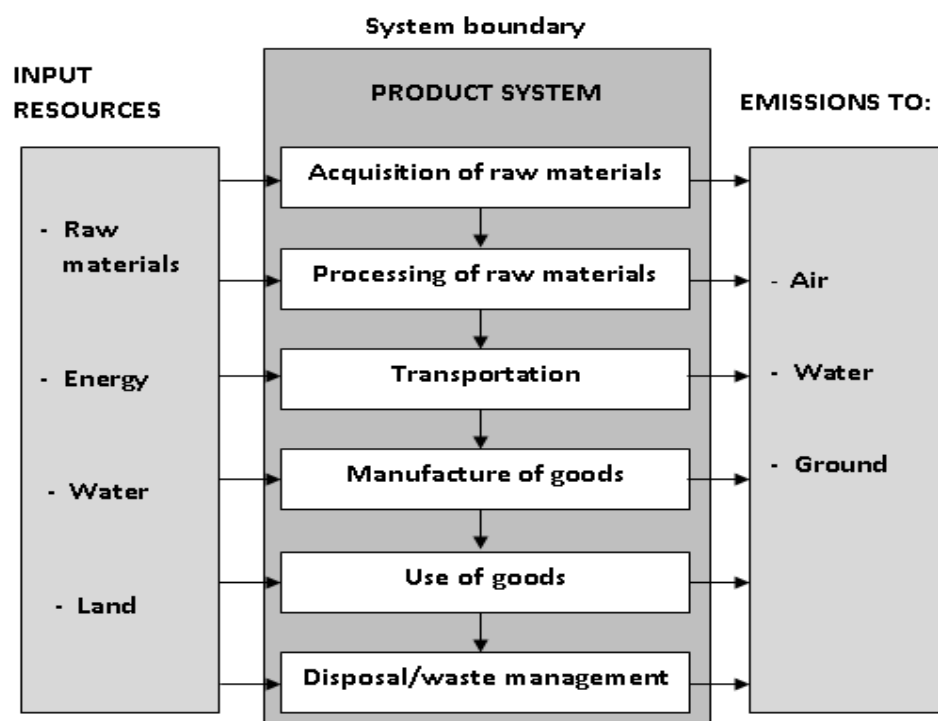

Figure 2.2. A generalized life cycle assessment model
(Adapted from Owens, 1997)

2.4.1. Development of LCA Methodology. The use of the LCA technique goes back to the 1960s (Curran, 1996; Owens, 1997; Ekvall, Tillman and Molander, 2005), though initially the technique went by various names (EPA, 2006). Before the name LCA came into being, practitioners of the technique referred to it by names such as, Energy Analysis, Product Ecobalances, Resource and Environmental Profile Analysis (REPA), Integral Environmental Analysis, Environmental Profiles, Product Line Analysis, and Integrated Chain Management (Curran, 1996; Guinée, 2002; Baumann and Tillman, 2004). While there are variations on historical accounts as to how LCA started, the general belief is that the first work that is now considered to be an LCA type study, was a

study commissioned by Coca-Cola Company in the US in 1969, in which the Midwest Research Institute (MRI) was engaged to evaluate alternative containers for beverage packaging (Baumann and Tillman, 2004; EPA, 2006). The evaluation considered energy, materials and environmental consequences, and it was referred to as Resource and Environmental Profile Analysis (REPA). At about the same time, somewhat similar studies, driven by concerns over energy and waste associated with packaging materials, were undertaken in Sweden, Germany and United Kingdom (Baumann and Tillman, 2004). Other LCA type studies followed, inspired by the initial efforts. The first LCA type studies carried out between 1969 and 1972 were all focused on packaging materials, especially for beverage containers (Curran, 1996; Baumann and Tillman, 2004). The oil crisis of 1973, further spurred development of LCA by fueling interest in detailed energy analyses (Owens, 1997; Baumann and Tillman, 2004), although analyses of environmental flows were limited in the studies (Curran, 1996).

Before the advent of common methodological rules or standards, results of LCA studies varied quite considerably because of the different approaches by individuals undertaking the studies (Buxmann, 2005). The Society of Environmental Toxicology and Chemistry (SETAC) was the first international body to work on the development of LCA methodology, with its initial involvement starting in 1989 (Guinée, 2002). SETAC put forth a science-based platform for development of LCA, and they formalized the LCA methodology by defining the terms to describe LCA as well as laying down the initial framework (Curran, 1996). SETAC developed a code of practice for LCA (Consoli et al., 1993) to reduce arbitrariness in the application of the technique (Guinée, 2002; Baumann and Tillman, 2004). SETAC continues to hold annual meetings aimed at improving the LCA methodology.

The development of the code of practice by SETAC was an important step towards standardization of LCA as the code acted as the forerunner to the activities of the International Organization for Standardization (Guinée, 2002). The International Organization for Standardization (ISO) started working on standards relating to LCA in 1994. The first of the ISO 14040 series of standards (Environmental management – Life cycle assessment), which laid down the procedure for performing LCA, was first released in 1997 (Baumann and Tillman, 2004). ISO standards pertain to the technical as well as

organizational aspects of LCA. The ISO Technical Committee 207 (ISO/TC207) has been focusing on, among others, defining terminology, establishing technical frameworks, structuring the analysis in different phases of LCA, and establishing general methodological requirements. ISO/TC207's contribution has been the reduction in the haphazard use of the tool by developing standards, which has improved the general acceptance of LCAs by stakeholders and the international community (ISO, 2006b). The ISO 14040 series of standards include the following standards and technical reports:

- ISO 14040: 2006 - Principles and framework (2nd Edition.)
- ISO 14041: 1998 - Goal and scope definition and inventory analysis (1st Edition)
- ISO 14042: 2000 - Life cycle impact assessment (1st Edition)
- ISO 14043: 2000 - Life cycle interpretation (1st Edition)
- ISO 14044: 2006 - Requirements and guidelines (1st Edition)
- ISO/TR 14047: 2003 - Examples of application of ISO 14042 (1st Edition)
- ISO/TS 14048:2002 - Data documentation format (1st edition)
- ISO/TR 14049: 2000 - Examples of application of ISO 14041 (1st edition)

The ISO 14040:2006 replaced the old ISO 14040: 1997, as well as the ISO 14041, ISO 14042 and ISO 14043, and brought them under one standard (ISO, 2006b). ISO has also developed other standards such as the ISO 14025:2006, which deals with principles and procedures for environmental labels and environmental product declarations, an area that is closely related to LCA.

The United Nations Environmental Programme (UNEP) is another important international player in LCA, having taken on the role of stimulating global use of LCA (Guinée, 2002). Their work mainly centers on encouraging the application of LCA, particularly in developing nations. In 1996 the UNEP published a user-friendly guide to LCA, as part of their effort to encourage wide application of LCA (Guinée, 2002).

2.4.2. Phases of LCA. The LCA model, as put forward by SETAC in the 1993 code of practice, had four main components (Figure 2.3). These are, Goal Definition and Scoping, Inventory Analysis, Impact Assessment, and Improvement Assessment. Over time, Improvement Assessment came to be viewed as one of the possible uses of LCA, rather than a step in the methodology (Baumann and Tillman, 2004). So, in the ISO 14041 standard, Improvement Assessment was dropped and replaced with Interpretation as shown in the ISO 14041:1998 framework model in Figure 2.4.

The removal of improvement assessment as a separate LCA phase was fitting because not all LCA studies necessarily require improvement assessment. For instance, some retrospective LCAs, such as stand-alone LCAs, are typically meant to compile baseline information for acquaintance with the environmental flows for product system or its components, without the intention for product or processes improvement, and for such studies, the improvement assessment phase would not be relevant. Despite its removal as a phase, Improvement Assessment remains part of LCA as it can be included in the goal of a study when there is an interest in assessing the effects on the environment of changes to the product system.

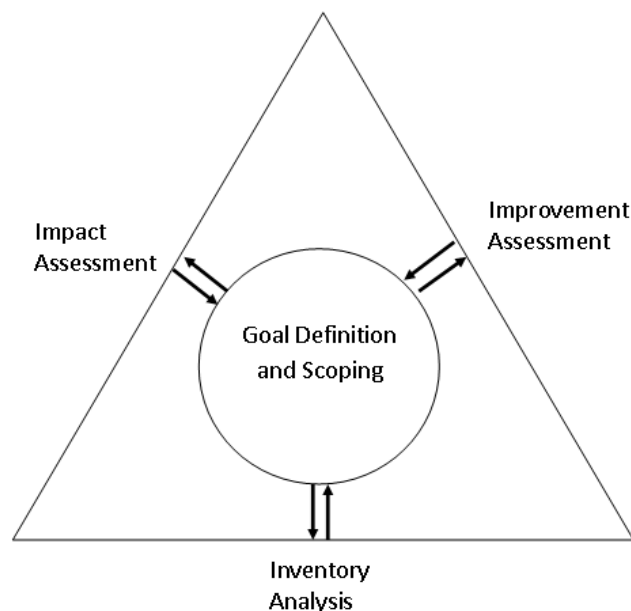

Figure 2.3. SETAC 1993 LCA framework
(Adapted from Curran, 1996)

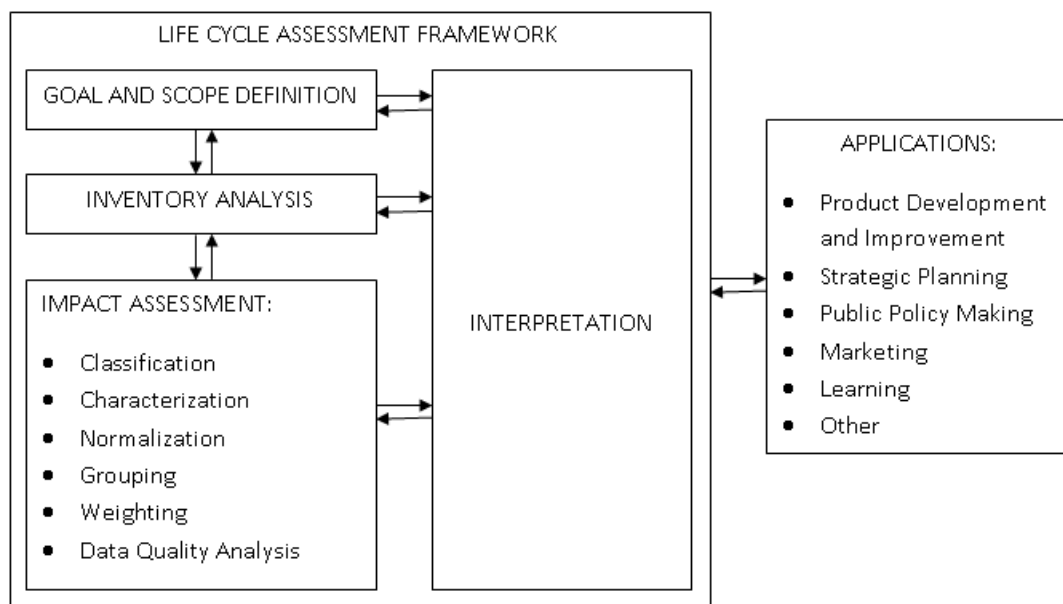

Figure 2.4. LCA framework according to ISO 14041:1998
(Adapted from Baumann and Tillman, 2004)

2.4.2.1 Goal and Scope Definition. An LCA study is carried out to answer specific questions, and these are the questions that guide the goal and scope of an LCA study (Curran, 1996). Aspects of this phase are defined and described in the ISO 14041:1998 and ISO/TR 14049:2000. In the goal definition, the purpose of the study or the context in which the LCA study is to be conducted is established, as well as the anticipated audience.

As part of the goal and scope definition, it is important to explain the nature of the study, i.e. whether it involves a prospective or retrospective LCA (Ekvall, 2005; Finnveden et al., 2009). A retrospective LCA study (also known as descriptive, accounting or attributional) describes the environmental flows to and from a life cycle and its subsystems (Höjer et al., 2008). Retrospective LCAs are useful for comparing existing products in marketing (Weidema, 2001), though some do not necessarily involve any comparisons, such as those for learning purposes (Ekvall, Tillman and Molander, 2005; Finnveden et al. 2009). On the other hand, a prospective (or change-oriented, effect-oriented or consequential) LCA aims to describe the consequences of changes made within the technological system investigated (Ekvall et al., 2005; Höjer et al., 2008), and is useful for decision making (Tillman, 2000).

The type of LCA has a bearing on the type, specificity and hence quality of data that is necessary to achieve results of some significance (Tillman, 2000). For retrospective LCAs, average data (which represents average environmental burdens for producing a unit of the product from the system) may suffice, while prospective LCAs typically require marginal data, which corresponds to the effects on the environmental burdens of the system due to a small change in the output of a product (Tillman, 2000; Ekvall et al., 2005; Finnveden, 2008).

In the goal and scope definition phase, the LCA practitioner defines the product, process system boundaries, impact categories of interest, as well as the format for presenting results. The functional unit, which is a quantified performance measure of a product system used as a reference unit in an LCA study, must be defined. The determination of the boundaries of an LCA project is critical to the completeness of the LCA (Raynolds, Fraser and Checkel, 2000), and it is based on a number of factors, including, the goal and scope of the project, the availability of data, and the time and resources available (Ahmadi et al, 2003; Rebitzer et al., 2004).

The ISO 14040 standard requires that where possible, scoping should be done quantitatively. The standard suggests that environmental outputs for all unit processes be evaluated to determine the unit processes' relevance, before the system boundaries are drawn. However, evaluating each unit process before deciding the boundaries of an LCA could prove to be impractical in terms of time and other resources required, especially for a system with lots of unit processes. Typically LCA practitioners select product system boundaries using qualitative evaluation in which one aims to include what they consider to be the main sources of life-cycle impacts. Raynolds et al. (2000) view this practice to be too arbitrary, and thus, would not ensure repeatable results.

To address the problem of selecting boundaries, Raynolds et al. (2000) proposed a method called the Relative Mass-Energy-Economic (RMEE) method. This is a systematic method to quantitatively determine whether or not certain unit processes should be included in the system boundaries, based on their relative mass, energy and economic values, compared to the functional unit. However, this method has limitations because it was developed specifically for energy sources. While it is applicable to coal, for instance, it is difficult to apply to most mining products such as metals, quarrying products and

others that have relatively low energy content compared to mass and economic values. In spite of the method's limitations, Awuah-Offei et al. (2008) have shown that it could be adapted to the non-energy mining products by disregarding the energy parameter and using different cut-off ratios for mass and economic value to match the different scales on which products for unit processes relate to the mass and economic value for the functional unit.

Depending on the intended use of the LCA, the system boundaries may be streamlined by eliminating some life cycle stages or some impact categories (Curran, 1996; Todd, 1996). Instead of a full LCA (cradle-to-grave assessment), one may choose to eliminate some downstream life cycle stages and do a cradle-to-gate assessment if the interest is on evaluation of a product from raw material extraction up to the point where the product leaves the boundaries of the production facility. Another streamlined version is a gate-to-gate assessment in which environmental releases or impacts of interest are only those directly from within the boundaries of the production facility.

2.4.2.2 Inventory Analysis. The inventory analysis phase is described in the ISO 14041:1998 and ISO/TR 14049:2000. In this phase, relevant energy, material and other resource inputs, as well as environmental releases to air, water, and land, and other environmental burdens, throughout the life cycle of a product are identified and quantified. The life cycle inventory (LCI) items are calculated as the functional unit's proportional share of the full environmental flows from each process (Finnveden et al. 2009).

2.4.2.3 Life Cycle Impact Assessment. The ISO 14042:2000 and ISO/TR 14047:2003 describe the steps in the life cycle impact assessment (LCIA) phase. In this phase, potential impacts are assessed based on impact categories defined in the goal and scope definition and the environment flows identified in the inventory analysis. The LCIA phase has several steps, which include classification, characterization, normalization, grouping, weighting and data quality analysis. In terms of the ISO 14042:2000 standard, classification and characterization are mandatory, while the other steps are optional.

2.4.2.3.1 Classification. Classification involves the assignment of the emissions from the inventory into impact categories according to the substances' ability to

contribute to different environmental problems (Baumann and Tillman, 2004). For example, sulfur dioxide (SO₂) can be assigned to acidification and photochemical ozone creation potential, and carbon dioxide (CO₂) and methane (CH₄) can be assigned to global warming potential.

2.4.2.3.2 Characterization. Following classification, characterization models are selected to model the impact of each emission quantitatively, according to the environmental mechanism (cause-effect chains) of the pollutants in order to give an impact score expressed in a common unit for the impact category (Pennington, et al., 2004). Characterization methods model the fate of pollutants in the environment to different extents: some modeling may be problem-oriented (midpoint modeling) or damage-oriented (endpoint modeling) (Mangena and Brent, 2006; Finnveden et al., 2009). The modeling approach determines the characterization factors (equivalency factors) used to convert the inventory estimates to potential impacts. For instance, in the climate change impact category, characterization factors expressed as kg CO₂-equivalent may be used for the change in absorption of radiation in the atmosphere due to greenhouse gas emissions, and this would represent midpoint (problem-oriented) modeling. On the other hand, the percentage of a particular species that has disappeared or the percentage of land submerged under water due to melting of ice in polar regions as a result of climate change caused by greenhouse emissions would represent endpoint (damage) modeling.

Characterization factors are also determined by the time scale used in the characterization modeling, as the lifetime of a substance has an influence on the substance's persistence in contributing to the particular impact over time (IPCC, 2007). As an example, the IPCC has developed global warming characterization factors for 20, 100 and 500-year time horizons, and the Global Warming Potentials for the longer time horizons reflect the importance of long-lived pollutant (IPCC, 2007).

2.4.2.3.3 Normalization. In normalization, the results from characterization are related to reference values, which express the relative magnitude of the impact scores on a scale which is common to all the impact categories (Bauman and Tillman, 2004). Normalization puts the significance of the characterization results in context, by relating the environmental burdens of a product (or service) to the overall burden in its

surroundings, and typically this is done at a national level and on an annual basis (Bare, Gloria and Norris, 2006; Mangena and Brent, 2006).

2.4.2.3.4 Grouping. Grouping involves sorting and ranking of indicators after characterization. This usually is a qualitative process in which indicators are grouped together and ranked based on level of importance, i.e. from high importance, medium importance to low priority (Pennington et al., 2004). The level of importance placed on indicators during ranking is usually based on social, political and ethical values, and thus, there is an element of subjectivity in grouping (Finnveden et al., 2009)

2.4.2.3.5 Weighting. Weighting allows different impact categories to be measured on a single scale so that the relative importance of the different environmental impact categories and resource consumptions can be evaluated (EPA, 1996; Finnveden et al., 2009). When weighting is used, the relative significance assigned to the impact categories depends on the goal of the study. Weighting may be necessary when trade-off situations occur, (e.g., where an improvement in one impact score results in a deterioration of another impact score). There are no set weighting factors that are considered correct and this makes weighting subjective (González, Adenso-Díaz and González-Torre, 2002; Pennington et al., 2004; Finnveden et al., 2009).

2.4.2.3.6 Data Quality Analysis. The final step in the LCIA phase is data quality analysis, which involves an analysis of the LCI or LCIA results to give an understanding of their reliability (Baumann and Tillman, 2004). When interpreting the results of an LCA, it is important to have an idea of the quality and uncertainty of the data (Finnveden and Lindfors, 1998), because that helps in judging the significance of the LCA results (Huijbregts et al., 2001; Basset-Mens et al., 2003). Even though, the step of data quality analysis is regarded as optional by the ISO 14042:2000, it is critical for ensuring that conclusions and recommendations drawn from LCA results are valid.

Huijbregts et al. (2001) divided sources of data uncertainty into two categories: data inaccuracy and lack of specific data, which is further divided into complete lack of data (data gaps) and unrepresentative data. They suggested these different sources of data uncertainty can be addressed by:

- Using economic input-output LCA models to estimate lacking data.
- Replacing missing data for products with that for main ingredients or components.
- Using uncertainty factors for non representative data.
- Using quantitative uncertainty propagation methods for dealing with data inaccuracies.
- Using sensitivity analysis to identify parameters that are important to the uncertainty of the LCA results.

The approaches suggested for dealing with data gaps are more relevant for manufacturing processes that involve use of ingredients or components, where such ingredients or components can be substituted with others. The methods may have limited use in processes that produce primary products, such as coal mining. For instance, when there is no data available for coal beneficiation processes, data for processing of other mineral products would most likely not be anywhere close to that for coal so as to allow for data substitution.

Sensitivity analysis can be used to identify parameters that are important and can significantly contribute to the uncertainty of the LCA results and which therefore need further uncertainty characterization (Huijbregts et al., 2001). Many concerns expressed about the accuracy of LCA results relate to failure to perform sensitivity analysis (Ross, Evans and Webber, 2002). While some LCA practitioners omit to do sensitivity analysis in their studies, generally this is an exercise that should be easy to carry out since it does not require parameters that often are not available. Sensitivity analysis should not be neglected, unless there is good data to allow for reliable quantitative uncertainty analysis.

Data uncertainty analysis should be an integral part of every LCA as it gives credence to the significance of the LCA results (Huijbregts et al., 2001; Ross et al., 2002). There are several techniques available for quantitatively estimating data uncertainties. To model and estimate data uncertainty in LCA, Chevaliar and Le Teno (1996) used intervals calculations; Yang, Luo and Zhou (2000); Tan et al. (2002);

Benneto et al. (2006) and González et al. (2002) used fuzzy data sets, and Awuah-Offei, Checkel and Askari-Nasab (2008) used Monte Carlo simulation. Other methods which have been used include analytical uncertainty propagation methods, Bayesian Statistics and Latin Hypercube simulation. Out of all these different techniques, stochastic modeling using Monte Carlo simulation is widely recognized as a valid technique for operationalizing uncertainty in LCA (Huijbregts et al., 2001). Despite the importance of modeling data uncertainty and the availability of various tools for doing that, modeling data uncertainty is not common practice in LCA (Huijbregts, et al., 2001).

Quantitative uncertainty analysis tools can give good characterization of data uncertainty, but the validity of their results depends on the quality of data distribution parameters used (Huijbregts et al., 2001). The main challenge in using these tools is that they require more data than is often available. The highly regarded probabilistic simulation tools in particular (e.g. Monte Carlo simulation), can only be useful if information on the probability distribution of the LCA input data is known, which is rarely the case in LCA studies (Maurice et al., 2000). The use of quantitative uncertainty analysis methods does not guarantee reliable LCA results (Lloyd and Ries, 2007). Thus, a quantitative analysis that is undertaken using poor information on the distribution of uncertainty is likely to be misleading. When quantitative uncertainty analysis is not possible, at least a qualitative assessment of the reliability of the data should be done (Ross et al., 2002). Qualitative analysis approach may not be as precise as quantitative methods, but it is still able to explain the sources of uncertainties to enable appropriate interpretation of the LCA results.

2.4.2.4 Life Cycle Interpretation. In the life cycle interpretation phase, the results are evaluated, significant issues are identified, conclusions are drawn and recommendations are made (ISO 14043: 2000). Conclusions and recommendations are made in the context of the defined goal and scope, and bearing in mind the limitations of the results.

2.4.3. Uses of LCA. LCA is receiving more attention from industry and regulatory authorities as an important tool for environmental systems analysis (Frischknecht and Rebitzer, 2005). LCA can be used in a number of ways to aid in decision making on environmental issues by the public, government and businesses.

2.4.3.1 Product Development and Improvement. One application of LCA that is gaining importance is eco-design, which is typically an internal company initiative to develop environmentally friendly products (Guinée, 2002). LCA has been identified as a key tool in implementing Design for Environment (DfE) or Green Design programs in industries (Yang et al., 2000). DfE programs are aimed at systematic design of products and processes in an environmentally conscious way. In these programs, LCA is used to identify opportunities for improving the environmental performance of products at various points in their life cycle. DfE is widely used in the construction and manufacturing industries (McLellan et al., 2009). For instance, the German automotive industry uses LCA in the design of new cars (Guinée, 2002; Finkbeiner et al., 2003).

While LCA and programs that employ LCA such as DfE are widely used in other industries, they have gained little attention in mining (McLellan et al., 2009). This could possibly be attributed to the concept of product improvement not being particularly applicable to many mining products. Unlike consumer products from manufacturing processes, most mining products cannot be made from any materials other than mineral ores and they are typically processed to meet purity specifications set by customers. For instance, there is not much improvement that could be done within the mining processes to produce a *better* diamond, or to refine metals in order to enhance their environmental friendliness. Rather, what is applicable to mining products in general, is process improvement to increase resource use efficiency and minimize emissions from processes. However, for coal, in addition to process improvement, product improvement may be applicable to some extent as coal generally is produced with impurities which influence emissions at the use stage. In this respect, LCA may be used for the improvement of a coal product's environmental flows over its life cycle by, for instance, optimizing coal washing to remove incombustibles and sulfur containing materials at the mine, versus coal recovery from washing, and fly ash and sulfur dioxide (SO₂) outputs from coal burning at a power generation plant.

2.4.3.2 Strategic Planning. LCA can be used for strategic planning, either internally within a business, or within an industry (Rebitzer and Buxmann, 2005), or at a national level by government (Baumann and Tillman, 2004). LCA results can be used to set priorities and decide on product or process design or redesign as a part of strategic

planning. When used this way, LCA can provide information that serves as the basis for company, industry or government strategies on pollution prevention, resource conservation and waste minimization.

2.4.3.3 Policy Making. Leading multinational firms have embraced LCA and integrated it into decision-making and processes for the formulation of internal policies (Hunkeler and Rebitzer, 2005). LCA can provide insight into environmental problem areas and improvement opportunities that could guide internal environmental policy formulation by businesses. Coal mining companies can also benefit from using LCA this way.

LCA can help in broadening the range of environmental issues considered in developing regulations or setting public policies (EPA, 1996). For example, The US DOE uses, as part of the criteria for selection of viable research proposals on development of biofuels and bio-based products, LCA backed credibility of environmental benefits (DOE, 2009a).

In the US, the use of LCA as a regulatory tool remains limited due to reluctance on the part of EPA to adopt it for such purpose (Baumann and Tillman, 2004), but this application in Europe is widespread. Examples of government policies include the ‘greening’ of the building industry in the Netherlands, which requires all building materials to be chosen based on LCA (Guinée, 2002), and the European Commission’s Integrated Product Policy (IPP) for sustainable development which relies on LCA among other tools for implementation (Andrae, Andersson and Liu, 2005; Frischknecht and Rebitzer, 2005).

2.4.3.4 Marketing. Baumann and Tillman (2004) suggested that marketing was the driver for the development of LCA methodology in general, particularly its standardization. Their argument stems from the criticisms of early LCA-type studies used in environmental product declarations, because of ambiguities in the applied methodologies (EPA, 2006). The now standardized LCA can be used to support product certifications or marketing declarations. Environmental product declarations are meant for environmentally conscious customers to make choices among several products and the choice ideally is based on environmental consequences of the products (Weidema, 2001). While purchase decisions for products are typically based on price, quality and

convenience, there is a portion of consumers who are willing to consider environmental impact information in their decisions, if such information is readily available in the form of point of purchase labels (Larson, 2009).

One prominent marketing scheme that uses LCA is the European Union Ecolabel (the EU flower), which promotes environmentally sound goods and services. In the Ecolabel scheme, after being subjected to rigorous studies over their entire life cycles, goods are awarded a distinctive symbol of environmental quality (EU Ecolabel, 2010). Other examples of eco-labeling based on LCA include the Blue Angel eco-labeling program of Germany and Green Swan eco-label of Scandinavia (Guinée, 2002). Although the marketing and sale of mining products such as coal takes a different form from that for consumer products, LCA may be used to market mining products, especially where the consumers use LCA in their processes and therefore are interested on inputs for which LCI data is available. Some mining companies use LCA to improve product stewardship and to have the impacts of their products known along the supply chain (BHP Billiton, 2008; Rio Tinto, 2008), and there have been claims of improvement in access to commodity markets as a result of this initiative (Rio Tinto, 2008).

2.4.3.5 Enhancement of Environmental Management Systems. LCA can be used to enhance environmental management systems for businesses (EPA, 2006). LCA has been used successfully in pollution prevention by reducing hazardous wastes and increasing recycling in some manufacturing industries (Curran, 1996). Alcan, one of the leading producers of aluminum materials and products, has employed LCA to expand the scope of its environmental management system to address their products' upstream and downstream impacts associated with suppliers and customers (Rebitzer and Buxmann, 2005). The unique capabilities make LCA an ideal tool to consider as part of a company's environmental management system.

2.4.3.6 Learning. Another important application of LCA is that of learning about environmental issues in general and about the relationships of product systems (Tillman, 2000; Ekvall et al., 2005). Many LCAs may be conducted with goals relating to product marketing, product improvement or policy making. However, there are LCAs that are carried out solely for learning purposes, with no specific action in mind (Finnveden et al., 2009). Also, irrespective of the intended goals, all LCAs provide a body of knowledge

from which learning points may be derived (Baumann and Tillman, 2004). Given the limited use of LCA in the coal mining industry, LCAs that focus on coal mining could offer industry players an opportunity to learn and appreciate the impacts of different mining processes.

2.4.4. Strengths and Weaknesses of LCA. The strength of the LCA technique lies in its holistic approach to evaluating the environmental burdens of a product or service (Guinée, 2002) and its quantitative nature (Muga, 2009). LCA considers aspects of the natural environment, human health, and resources use (Finnveden et al., 2009), and it incorporates a broad array of environmental elements and impact categories (Owens, 1997), compared to other environmental evaluation methods such as ecological footprint (which focuses only on land area) and chemical risk assessment (which only covers toxicity of chemicals). The comprehensive scope of LCA is useful in avoiding problem-shifting (Guinée, 2002; Finnveden et al., 2009). The cradle-to-gate approach and the wide array of impact categories, enables tracking and capture of any transfers of environmental problems between stages of the life cycle of a product, from one place to another, and from one media to another, which could inadvertently happen as a result of changes in processes.

The holistic approach of LCA, which is its strength, is at the same time its limitation (Guinée, 2002). The approach leads to requirements for lots of data, which is often not readily available (Ayres, 1995; Tan, Culaba, Purvis, 2002; Ahmadi et al., 2003; Durucan, Korre and Munoz-Melendez, 2006). The success of any given study is driven by the availability of good data, and the lack of readily accessible and credible data has limited the number of LCA studies (Curran, Mann and Norris, 2005). This problem of data availability may be addressed to some extent by streamlining the scope on an LCA study to take into account the data that can reasonably be acquired given the time and other resource constraints.

One shortfall that has been cited with LCA is that the potential impacts are presented in the form of aggregated environmental loads or impacts, without considering their distribution over time and space (Owens, 1997; Zhang et al., 2006). However, detailed temporal and spatial differentiation cannot be feasible for all processes in an ordinary product LCA (Sonnemann, Castells and Schuhmacher, 2004). Thus, aggregation

of impacts across temporal and spacial aspects is sometimes inevitable, especially when a product has to be evaluated across all stages in its life cycle. This is because a product does not exist in isolation at a particular facility, it is rather linked to other processes and activities through suppliers of materials and customers (Curran, 1996), and these processes and activities, while they occur at different locations and at different times, have to be all taken into account. However, where there is a need for site specific or process specific data, aggregation may be reduced or eliminated by focusing the system boundaries on the particular site or process using a streamlined LCA, (e.g. gate-to-gate assessment).

With respect to all the aspects of sustainability, the conventional LCA framework has the limitation that it deals only with the environmental aspects of products and service but does not cover economic and social impacts (Guinée, 2002; Reich, 2005; Muga, 2009; Finnveden et al. 2009). Further, from an industrial perspective, conventional LCA models do not address product performance and costs (Gäbel and Tillman, 2005). While these assertions are true, it has to be borne in mind that LCA is not meant to replace other tools that may have the capability to evaluate social and economic aspects, but rather it is intended to compliment them in the overall evaluation of products. However, there is ongoing work to broaden the scope of LCA to take into account social and economic aspects (Höjer et al., 2008; Finnveden et al., 2009). There are other tools that are being developed or have been developed that are modeled around the LCA framework. For instance, The Pembina Institute has developed and uses Life Cycle Value Assessment (LCVA), a multidisciplinary tool modeled around the LCA framework, which integrates economic, social and environmental aspects as well as systems thinking (Pembina Institute, 2007). There is also the economic input-output LCA (EIO-LCA) model, initially developed by the Carnegie Mellon's Green Design Initiative, which integrates economic and environmental aspects of products (Hendrickson, Lave and Matthews, 2006). Another tool that is emerging as a likely contender for adding the second dimension of economic aspect to LCA is Life Cycle Costing (LCC) (Hunkeler and Rebitzer, 2005). LCC attempts to link economic information to LCA by monetizing environmental effects (emissions and resources) in the life time of a product (Reich, 2005; Krozer, 2008; Höjer et al., 2008).

The integration of economic, social and environmental impacts in LCA still has some challenges. For instance, the EIO-LCA model has limited use because it lacks precision (Huijbregts et al., 2001; Hendrickson et al., 2006), and the current software and databases have data for a few countries only (Finnveden et al. 2009). Work on LCC is still at early stages as there is still a need to refine and standardize the methodology (Reich, 2005; Hunkeler and Rebitzer, 2005).

2.5. LCA APPLICATIONS TO MINING AND COAL

The first LCA type study was on beverage containers and the studies that followed between 1969 and 1972 all focused on packaging (Baumann and Tillman, 2004). Since then, LCA has been applied to evaluate various products, including, solar thermal collectors (Battisti and Corrado, 2005); a digital system telephone (Andr , Andersson, and Liu (2005); computer monitors (Socolof, Overly and Geibig, 2005); biofuels (Tan et al., 2002; Fast, 2008) and natural gas used in thermal energy generation (Dinca, Rousseaux and Badea, 2007). Others have used LCA to evaluate building and construction products, including wallboard (Chevalier and Le Teno, 1996); cement (G bel and Tillman, 2005); linoleum floors (Gorree et al., 2000); aggregate materials (Carpenter, 2009); and red clay used in the manufacture of ceramic tiles (Bovea et al., 2007).

Apart from evaluation of products, LCA has been used to evaluate and compare management options for waste and polluted sites. Studies in this regard include, evaluation of management options for municipal solid waste landfills (Reich, 2005; Wanichpongpan and Gheewala, 2007; den Boer, den Boer and Jager, 2007); wastewater treatment (Lundie, Peters and Beavis, 2004; Pitterle, 2009); and coal combustion products (fly ash) from coal fired power generation (Hansen, Notten and Petrie, 2002; Babbitt and Lindner, 2008). Bayer and Finkel (2006); Cadotte, et al. (2007) and Lesage et al. (2007) used LCA to evaluate and compare alternative scenarios for rehabilitation and remediation of polluted sites. These applications to different products and processes prove the versatility of LCA.

Electricity use features prominently in LCA studies for a majority of products (Curran, Mann and Norris, 2005), and this is because most industrial systems link directly or indirectly to the electricity system (Kim and Dale, 2005). This link between electricity and products points out to the importance of electricity data in LCAs for products in general. Coal-fired power generation accounts for a significant portion of electricity generated in the US and around the world, and therefore, LCI data for coal are vital for achieving comprehensive LCI data for electricity generation and many products. In fact, the lack of LCI data on coal mining has been cited as one of hindrances to the accuracy of LCI data on electricity generation (Kim and Dale, 2005).

There have been a number of LCA studies on electricity generation systems. Among the studies are, fossil-fired generation plants (Widiyanto et al., 2003) and the US electricity system, which is dominated by coal fired generation (Kim and Dale, 2005). Studies focusing specifically on coal fired generation include, generation in a Finnish plant (Sokka, Koskela and Seppälä et al., 2005); generation plants in Germany (Schreiber, Zapp and Kuckshinrichs, 2009); power plants in Florida, US (Babbitt and Lindner, 2005); plants in the Great Lakes region of the US (Froese et al., 2010); and coal gasification plants that use Illinois coal (Ruether, Ramezan and Balash, 2004). In these studies, generally, mining processes are treated as background to the main system under study (electricity generation), and as such, the detail on mining processes and the associated environmental flows is limited and in some instances environmental flows that are important in mining processes are excluded.

Some electricity LCAs use national or state average figures for coal mining with no specificity to any particular method of coal mining. For instance, Shreiber, et al. (2009) used average figures for German coal mix with no reference to the mining methods used; Ruether et al. (2004) used Illinois coal mining averages; and Babbitt and Lindner (2005) used the US coal mix which includes aggregated data for both surface and underground coal mining methods.

With respect to the level of coverage of environmental impacts that pertain to mining, the LCAs on electricity generation mostly include energy use in mining and associated emissions, but they leave out some impacts that are predominant in the mining stage, such as land use. For instance, Froese et al. (2010) considered coal from surface

mining operations in the Powder River Basin, but their study was limited to greenhouse gas emissions only. None of the studies on electricity generation includes land use impacts from mining.

Despite the applications in a variety of products and processes, Awuah-Offei et al. (2008) suggested that LCA applications in mining are limited. As is the case with mining in general, LCA studies that focus on coal mining are limited as well. A search of the International Journal of Life Cycle Assessment, which exclusively features LCA studies and related literature, confirms this. Searching the journal database using the keywords 'coal mining' yields 23 results out of the 1,230 publications in 15 volumes. Of these results, only 2 papers (Babbitt and Lindner, 2008 and Shreiber, et al., 2009), actually deal with coal mining activities. On the other hand, searching with the keywords 'building products', 'power plant', 'automobile' and 'biofuels' yields 429, 274, 95 and 46 papers, respectively. These results reflect the relatively low LCA applications to coal mining products, compared to other products.

Cases of LCA applications focusing on coal mining include, the evaluation and comparison of environmental performance of South African coal products with their economic values (Mangena and Brent, 2006); the use of Eco-indicator 99 to conduct an LCA of coal produced by longwall mining in Poland (Czaplicka-Kolarz, Wachowicz and Bojarska-Kraus, 2004); and an LCA of anthracite coal production in Vietnam (Chihn et al., 2007). The LCI of coal used in power generation in Florida (Babbitt and Lindner, 2005) includes the coal mining stage. The studies by Chihn et al. (2007) and Babbitt and Lindner (2005) use aggregate data for coal from surface and underground mining methods, and therefore they do not clearly reflect environmental flows and impacts that are specific to surface coal mining. While Mangena and Brent (2006) have separate assessments for surface and underground mines and cover a number of impact categories important to coal mining, their study characterizes and normalizes the impacts in the context of the South African situation. In essence, none of the studies is specific to surface coal mining in the US.

The National Renewable Energy Laboratory (NREL) of the DOE has developed the US LCI database (www.nrel.gov/lci/database) for various products including coal mining products. The database has cradle-to-gate LCIs for anthracite coal from

underground and surface mines; bituminous coal from underground and surface mines; and lignite from surface mines in the US (see Table 2.1).

The inventories are not complete as they do not include some environmental flows that are important to coal mining. For instance, while methane emissions have been included, other greenhouse gas emissions (e.g. CO₂ emissions from equipment operation and electricity generation) have not been included. The partial data for coal mining in the LCI database is evidence of the limited LCA studies of coal mining in the US and the resultant data gap.

Table 2.1. Cradle-to-gate LCIs for mining of different coal types (NREL, 2008)

Flow Info Explanations	Flow Info - Name	Unit	Lignite coal	Bituminous coal	Anthracite coal
Inputs from Technosphere	Coal combusted in industrial boiler	kg	3.62×10^{-4}	4.31×10^{-4}	1.70×10^{-1}
	Diesel combusted in industrial boiler	L	1.50×10^{-2}	8.80×10^{-3}	3.64×10^{-3}
	Electricity at grid, US	kWh	5.33×10^{-2}	3.87×10^{-2}	2.12×10^{-2}
	Gasoline combusted in equipment	L	1.41×10^{-3}	8.36×10^{-4}	2.68×10^{-4}
	Natural gas combusted in industrial boiler	m ³	2.51×10^{-4}	1.62×10^{-4}	2.32×10^{-4}
	Residual fuel oil combusted in industrial boiler	L	1.45×10^{-3}	8.70×10^{-4}	1.34×10^{-3}
	Dummy disposal, solid waste	kg	2.35×10^{-1}	2.35×10^{-1}	2.71×10^{-1}
Inputs from Nature	Coal resource in ground	kg	1.00	1.24	1.27
	Energy content of coal in ground	MJ/kg	1.45×10^1	2.48×10^1	3.07×10^1
Outputs to Nature	Methane to air	kg	1.13×10^{-3}	3.99×10^{-3}	1.59×10^{-3}
	Particulates, unspecified, to air	kg	9.80×10^{-5}	1.63×10^{-3}	2.10×10^{-3}
	Volatile organic compounds (VOC) to air	kg		2.57×10^{-5}	3.18×10^{-5}
	Iron to water	kg	2.65×10^{-8}	8.64×10^{-6}	2.22×10^{-5}
	Manganese to water	kg	1.76×10^{-7}	5.76×10^{-6}	1.48×10^{-5}
	Suspended solids, unspecified, to water	kg	1.98×10^{-6}	1.00×10^{-4}	2.59×10^{-4}
Product Output	Coal at mine	kg	1	1	1

In view of the limited LCAs of coal products in the US and the data gaps reflected in the US LCI database, there is need for more LCA studies that focus on coal products in the US. It is also vital to have LCIs for different mining methods in order to give an understanding of the environmental flows for each mining method used in the extraction of coal in the US.

2.6. CHALLENGES IN APPLYING LCA TO COAL MINING

There are some challenges in applying LCA to mining processes that could perhaps be hampering acceptance and use of LCA in the coal mining industry. These include a lack of data, shortfalls in the current LCA framework to address issues peculiar to mining, and possible limited awareness of the LCA methodology in the coal mining industry.

2.6.1. Lack of Data. Many LCA practitioners have cited the scarcity of data as a major challenge in conducting LCAs (Curran, 1996; González, Adenso-Díaz and González-Torre, 2002; Durucan et al., 2006). Most of the good quality data necessary for LCA is confidential to companies (Ayres, 1995; Durucan et al., 2006). This situation holds true for the coal mining industry as companies typically try to keep away information on processes and performance data from competitors. Some industries, through collective efforts of industry players, have developed LCI databases and LCA reports for their products. Examples include, LCI database of North American plastic products sponsored by the American Plastics Council (APC) and the Environment and Plastics Institute of Canada (EPIC) (Vigon, 1996); global LCI database for steel products by the World Steel Association (Worldsteel, 2009); LCA report of nickel by the Nickel Institute (Middleton and McKean, 2005); and LCI reports for worldwide production of primary aluminum by the International Aluminium Institute (IAI, 2003). However, there is no similar collaboration by the coal mining industry to develop an industry sponsored LCI database of coal products. Such an initiative by the coal mining industry associations could encourage individual companies to conduct their own LCA studies and benchmark against others for improvement. That could be the starting point for generation of industry specific data.

The LCA framework has a wide array of impact categories and the environmental flows for some impact categories have not been regulated before or are not regulated at all, and so, data for these may not be routinely collected and analyzed by mining companies (Owens, 1997). The wide array of LCA impact categories should not be viewed as an impediment, but rather as a framework that provides companies an opportunity to look beyond regulatory compliance and to improve operational efficiencies, reduce operating costs and improve their public image.

2.6.2. Limited Specificity to Mineral Products. Lindeijer (2005) made the observation that the current LCA framework does not address mining issues adequately, citing the lack of specificity to mineral products. Traditional LCA impact categories defined by SETAC include global warming, ozone depletion, human toxicity, ecotoxicity, photo-oxidant formation, acidification, eutrophication, odor, noise, and radiation potential impacts (Baumann and Tillman, 2004). These impact categories do not sufficiently address all potential impacts that are important in mining (Stewart, 2005; Bovea et al., 2007). Various LCA practitioners have argued for land use, water use, energy use and resource depletion as impact categories that need attention in mining LCAs (Spitzley and Tolle, 2004; Bauer and Zapp, 2005; Morris, 2005; Mangena and Brent, 2006; Durucan et al., 2006; Strauss, Brent and Hietkamp, 2006; Bovea et al., 2007).

In weighing the arguments for and against inclusion of resource depletion in mining LCAs, Morris (2005) concluded that resource depletion is not important for minerals such as metals, but rather, it is important for fossil fuel energy sources. This argument holds true considering that while metal grades on the ground progressively become diminished with mining of high grade ores, mined metals accumulate above the ground (in the technosphere) where they can be recovered, recycled and put back to use. Also, some metals can substitute each other, or can be substituted by other materials in products (Middleton and McKean, 2005). However, fossil fuels, unlike metals, are not recyclable and once used they are destroyed. Given that fossil fuels take millions of years to form, they can be considered as non-renewable, so that the available reserves would eventually get depleted. Thus, the impact category of resource depletion is relevant and particularly important to coal and other fossil fuels.

Bourassa (2005); Lindeijer (2005) and Bovea et al. (2007) suggested that land use impacts in mining are a dominant contributor to changes on global biodiversity, and therefore deserve attention in LCAs. Land use as an impact category is especially relevant and important to surface coal mining given the exceptionally large surface area footprint associated with surface coal mining compared to underground mining methods or surface mining of other mineral resources. Therefore, land use impacts should be not neglected when conducting LCAs of coal from surface mining operations.

Water consumption has been identified as one of the important considerations in evaluating the environmental performance of mining operations (Baur and Zapp, 2005). Water is a resource whose availability varies from site to site, and mining uses compete with other uses (Baur and Zapp, 2005; Mangena and Brent, 2006). High water consumption rates in mining operations could lead to water depletion in arid areas, especially where fossil ground water is the most important water source (Mangena and Brent, 2006). Baur and Zapp (2005) have suggested that water consumption could be considered under LCIA category of extraction of abiotic resource. However, the challenge in this characterization of water depletion is that, water is a renewable resource that continues to be replenished as it is consumed. Thus, the concept of depletion would be valid when there are certainties that a water source does not get any recharging or that the extraction rates exceed recharging rates. Another problem is that characterizing water consumption in mining may tend to be value-based because concerns over scarcity of water may vary from site to site. So, to deal with water consumption in LCAs of mining products, it may suffice to include it as part of resource inputs in the inventory, as characterizing it in the LCIA phase can only be justified within the context of a particular area or region.

2.6.3. Ambiguity of Results Due to Aggregation. The problem of ambiguity and concealment of site specific impacts due to aggregation of data in life cycle impact assessment has been put forward by various LCA practitioners (Owens, 1997; van Zyl, 2002; Lindeijer, 2005; Durucan, et al., 2006). Due to the unique situation of each mine, there is usually interest in site-specific information (van Zyl, 2002; Durucan, et al., 2006). Site-specific impacts are relevant for ensuring that effective measures are developed to address environmental problems for a particular site (McLellan, 2009). One level of

aggregation of results occurs in the mandatory steps of LCIA: classification and characterization. To prevent total concealment of site-specific environmental flows in LCA results, the inventory data for different life cycle stages could be presented separately so that it is available in non-aggregated form to allow for assessment of impacts for any life cycle stage of interest.

Ambiguity in LCA results has mainly been attributed to aggregation using the value-based optional steps of the LCIA phase (Stewart, 2005; Lindeijer, 2005). Steps such as grouping and weighting are the main problem in this regard, because there are no standardized factors for grouping and weighting. The problem of ambiguity in the results due to optional LCIA steps can be averted by limiting the use of such steps.

2.6.4. Arbitrariness in Selection of Functional Unit. One aspect of LCA that causes problems in LCA studies is the selection of functional unit. Other than the requirement for a functional unit to be expressed in quantitative terms, the ISO 14041:1998 standard does not prescribe values for functional units. With LCA practitioners left to make their own choices of functional units, the result is arbitrariness (Olsen et al, 2001). For instance, six LCA studies on electricity generation used five different functional units, and these included, 1 kWh (Froese et al., 2010; Schreiber et al., 2009); 1 MWh (Sokka et al., 2005); 1TWh (Maurice et al., 2000); 1 MJe (Kim and Dale, 2005) and 1000 kg of coal combusted (Babbitt and Lindner, 2005). The NREL's LCI for coal products are based on one kilogram (1 kg) of product, while some LCA studies on coal mining (Mangena and Brent, 2006; Czaplicka-Kolarz et al., 2005; Babbitt and Lindner, 2008) use one metric ton (1 tonne). While these studies were looking at similar products, the different functional units make it not so easy to readily compare the results.

The lack of standardized common functional units allows for flexibility in order to cater for the myriad possible functions that LCA practitioners may wish to investigate, but it also makes the comparison of LCA results of similar products cumbersome. While the constraints that could result from standardizing functional units are appreciated, there is need to at least have some recommended common functional units to allow for easily comparable results and to enable easy borrowing of data from other studies. Functional units derived from units of measure typically used in respective industries may be useful in this regard.

2.6.5. Arbitrariness in Selection of System Boundaries. One of the problems that have been identified in the application of LCA to mineral products is the different definitions of boundaries for some mining processes in some studies (Stewart, 2005). Typically system boundaries are selected using some qualitative criteria decided on by individual LCA practitioners, and this leads to inconsistent results for products and processes that are supposed to be similar. A method that ensures transparency and consistency such as the RMEE method proposed by Reynolds et al. (2000) could be used to quantitatively determine the unit processes that are of significance and therefore should not be left out of the system boundaries.

2.6.6. Limited Awareness of LCA Methodology. LCA developed with a relatively small circle of academics and consultants and many, including mining engineers, are still coming to grips with it as it is being rolled out to different industries (Middleton and McKean, 2005). Thus, LCA is generally not yet well understood and appreciated within the mining industry. It is only a few leading mining corporations that appreciate its benefits. It is through exposure of industry players to the tool through LCA studies of mining products that perhaps interest in the tool could be generated.

2.6.7. Lack of Expertise and Resources. LCAs are not simple, nor are they cheap, and this inhibits their use by small companies (Hoskins, 2005). Given the limited expertise on LCA in the mining industry, the industry has had to rely on expensive consultants to carry out LCAs to satisfactory standards (Middleton and McKean, 2005). The lack of adequate resources, including knowledgeable personnel, is likely to limit the use of LCA for the many small operators in the US coal mining industry.

3. GOAL AND SCOPE DEFINITION

In this chapter the goal and scope of the LCA study are set out, and the life cycle impact assessment categories of interest are defined. The background information of the case study mining operations is given and the data relevant for the LCA is identified. The product system is described and unit processes to be included in the system boundaries are selected (scoping).

3.1. GOAL OF THE STUDY

The LCA work was intended to give an appreciation of the contribution of the coal mining stage and sub-processes to the overall life cycle impacts of coal. The goal of this LCA study was to estimate the cradle-to-gate life cycle impacts associated with surface coal mining for five mines in the US, and to compare the potential impacts for the operations. LCA was applied to explore the environmental flows associated with the production of bituminous grade coal from different operations that use area strip mining method. The study involved using general principles of ISO 14040 - 49 series of standards for LCA and adapting them where appropriate to the unique situation of surface coal mining. Specifically, the study aimed to:

- a. Collect data on energy sources, water use and land use and where energy data are missing, to model energy requirements for the operations based on available data on major equipment used in the operations;
- b. Conduct an inventory assessment of resource inputs and emissions for the production of coal in each mine;
- c. Assess the life cycle impacts for categories of climate change, energy use, resource use and depletion, water use, as well as land use for each operation.
- d. Compare environmental performances (measured by life cycle impacts) of the operations and explore the sources of differences in performance.

- e. Conduct sensitivity analysis and discuss issues of data uncertainty.
- f. Suggest improvement measures to address sources of impacts.

3.2. TYPE OF LCA

A retrospective (accounting) type of LCA was used to explore the environmental flows associated with the production of bituminous coal for the different mines. Thus, rather than being an effect-oriented type LCA, this study aimed at giving a descriptive assessment of each operation. The study is also comparative, comparing the magnitudes of potential environmental impacts for the mines and evaluating the effects of scale of operation, energy sources and geological conditions on the environmental performance of the operations.

3.3. TARGET AUDIENCE

It was hoped that the results of this study would contribute towards addressing the LCI data gap on coal mining products, as well as pinpoint critical sources of impacts that could aid the coal mining industry and public policy makers in the development of strategies and policies to curb the environmental impacts of coal. Further, it was hoped that the study would find audience among LCA practitioners who could build upon the results of this study and improve LCA applications in coal mining, and mining in general.

3.4. SOURCES AND SPECIFICITY OF DATA

The data for the LCA was obtained from environmental impact statements, coal mining permit applications, government reports, and published literature. Data of interest for the LCA included geological information, coal production, land disturbance activities, water consumption, fuel and electricity consumption, as well as other major mining material inputs. Other relevant data included major production equipment, and operating schedules.

The comparative nature of this LCA necessitated that, as much as possible, data collected be specific to the respective operations. Where generic data was used, the data was adapted to the specific situation or conditions of the operation. To ensure the technological aspects of the data used were comparable, mines that employ similar mining methods were selected, although the mines operate at different scales of production, and they are located in coal basins of varying geological conditions. For consistency in the temporal aspect of the data, the data chosen on energy use is for the time period when all the mines were in operation (2003 to 2005).

3.5. BACKGROUND ON THE CASE STUDY MINES

In the study, data for five surface mines designated as Mines A1, A2, B, C, and D, were used to evaluate the LCA impacts of coal mining. The locations of the mines are shown in Figure 3.1.

3.5.1. Mines A1 and A2: Black Mesa and Kayenta. Black Mesa (Mine 1A) and Kayenta (Mine A2), owned by Peabody Western Coal Company, operated in two contiguous mine leases located in the Hopi and Navajo Nation tribal lands in Northern Arizona. Black Mesa started operating in 1970 while Kayenta began in 1973. Black Mesa produced 4.8 million tons of coal annually until it stopped operating in December 2005 due to suspension of the operations at Mohave Generating Station in Nevada, which was its sole customer. Following the cessation of operations at Black Mesa, the permit areas for the two mines were consolidated into one and Kayenta continues to produce 8.5 million tons, annually.

The coal mined is from the Wepo formation, which has up to seven coal horizons. The thicknesses of the seams vary from area to area, and in some areas, some seams are completely absent due to erosion. The combined seam thickness ranges from 3 to 18 ft and averages 6.5 ft, with an average combined overburden and interburden thickness of about 38 ft. Overburden and interburden materials are removed primarily using draglines. Partings of 3 to 15 ft thickness are removed using shovels, front-end loaders and dump trucks, while those less than 3 ft are removed using dozers. Shovels, front end loaders and dump trucks are used to move the exposed coal and transport it to the coal preparation



Figure 3.1. Locations of the case study mines (Map adapted from The University of Alabama, 2010)

plants. General parameters for the two mines are shown in Table 3.1 and average data on coal production, energy consumption, water consumption and coalbed methane emissions for the years 2004 and 2005 are presented in Table 3.2.

Table 3.1. Black Mesa and Kayenta parameters (OSMRE, 2005 and 2008)

PARAMETER	VALUE
Average coal seam thickness	6.5 ft (2.0 m)
Average overburden thickness	37.9 ft(11.6 m)
Energy content	12, 805 Btu/lb (29,784 MJ/tonne)
Ash content	7.53%
Sulfur	0.66%
Coalbed methane	1.55 lb/ton coal (0.78 kg/tonne)
Annual production	13 million tons (11.8 million tonnes) until Dec. 2005. 8.5 million tons (7.7 million tonnes) starting 2006.
Reserves	Total Reserves: 803 million tons (728 million tonnes) 368 million tons (334 million tonnes) mined up to Dec. 2005. 435 million tons (395 million tonnes) left as at Jan. 2006.
Permit land area	Total permit area: 64,585 acres ($2.61 \times 10^8 \text{ m}^2$) Coal mining area: 37,240 acres ($1.51 \times 10^8 \text{ m}^2$) Disturbed mining area: 11,865 acres ($4.80 \times 10^7 \text{ m}^2$) up to Dec. 2005 Facilities: 1, 680 acres ($6.80 \times 10^6 \text{ m}^2$) Non disturbance area: 25,665 acres ($1.04 \times 10^8 \text{ m}^2$)

Table 3.2. Black Mesa and Kayenta average data for 2004 and 2005 (OSMRE, 2008)

PARAMETER	VALUE
Coal Production	12.1 million tons (11.0 million tonnes)
Electricity Consumption	$1.406 \times 10^8 \text{ kWh}$
Diesel Consumption	7.9 million US gallons (29.7 million liters)
Gasoline Consumption	0.46 million US gallons (1.7 million liters)
Propane Consumption	0.93 million US gallons (3.5 million liters)
Water Consumption	1750 acre-foot ($2.16 \times 10^9 \text{ liters}$)
Coalbed Methane Emissions	0.93 million US gallons ($3, 535 \text{ m}^3$)

3.5.2. Mine B: Wildcat Hills Mine, Cottage Grove Pit. The Wildcat Hills Mine, Cottage Grove Pit, operated by Black Beauty Coal Company, LLC., is located in Saline County, Illinois. The mine was developed in 2000 and coal production started in July 2001. The mine operates two 8-hour shifts per day for seven days a week producing about 670, 000 tons of processed bituminous coal, annually. Production from the mine is by means of shovels, front-end loaders, dozers and haulage trucks. Coal from the mine is processed at the 1,400 ton per hour Willow Lake Preparation Plant, which also processes coal from Wildcat Hills Underground Mine and Willow Lake Mine. The plant produces 3.7 million tons of coal per annum.

Five coal seams are mined and they include Danville No.7, Allenby, and Herrin No. 6 in one section of the mine, as well as Briar Hill No. 5a and Springfield No. 5 in the other section. Overburden thickness ranges from 63ft to 139ft and averages 88.5ft, while the combined seam thickness averages about 6.5ft. Table 3.3 shows parameters for Cottage Grove Pit

Table 3.3. General parameters for Cottage Grove Pit (Arclar, 2009)

PARAMETER	VALUE
Average coal seam thickness	6.48 ft (2.0 m)
Average overburden thickness	88.5 ft (27.0 m)
Energy content	12, 183 Btu/lb (28,337 MJ/tonne)
Ash content	17.1%
Sulfur	3.8%
Coalbed methane ¹	1.32 lb/ton (0.66 kg/tonne)
Annual production	0.67 million tons (0.61 million tonnes)
Reserves	Total Reserves: 7.7 million tons (7.0 million tonnes) 5.4 million tons (4.9 million tonnes) mined up to Dec. 2008. 2.333 million tons (2.1 million tonnes) left as at Jan. 2009.
Permit land area	Total permit area: 895.1 acres (3.62 x 10 ⁶ m ²) Coal mining area: 548.7 acres (2.22 x 10 ⁶ m ²) Facilities: 105.6 acres (4.27 x 10 ⁵ m ²) Non disturbance area: 240.8 acres (9.74 x 10 ⁵ m ²)

¹ Coalbed methane emissions for Illinois Basin coal (Kircheggner, Piccot and Masemore, 2000).

3.5.3. Mine C: Cottonwood Creek Mine. The Cottonwood Creek Mine, owned by Continental Coal Company, is located in Bates County in Western Missouri. It started operating in 2003 and produces an average of 200,000 tons of bituminous coal, annually. The mine works two 8-hours shifts per day for seven days in a week.

Overburden material is blasted and removed using dozers, excavators, front-end loaders and dump trucks. Coal is ripped by dozers and loaded into trucks for transportation to the plant. Coal is crushed, gob material removed, and then screened to size. The processing plant has three 300 ton/hour crushing plants, but only one operates at a time. Electrical power is supplied by an internal combustion diesel generator on site (1.65MMBtu/hour capacity), which powers the crushing and screening plants.

Coal extracted is from the Mulberry coalbed, which has a mineable seam ranging in thickness from 12 to 42 inches and averages 26 inches. Overburden thickness averages about 48 ft. The parameters for Cottonwood Creek Mine are shown in Table 3.4.

Table 3.4. General parameters for Cottonwood Creek Mine (Continental, 2009)

PARAMETER	VALUE
Average coal seam thickness	26 inches (0.66 m)
Average overburden thickness	48 ft (14.6 m)
Energy content	10,900 Btu/lb (25,353 MJ/tonne)
Ash content	16.0%
Sulfur	3.7%
Coalbed methane ¹	1.49 lb/ton (0.75 kg/tonne)
Annual production	0.2 million tons (0.18 million tonnes)
Reserves:	Total Reserves: 1.5 million tons (1.4 million tonnes) 1.01million tons (0.92 million tonnes) mined through Dec. 2008. 0.49 million tons (0.44 million tonnes) left as at Jan. 2009.
Permit land area	Total permit area: 694 acres (2.81 x 10 ⁶ m ²) Coal mining area: 560 acres (2.27 x 10 ⁶ m ²) Facilities: 42 acres (1.70 x 10 ⁵ m ²) Non disturbance area: 92acres (3.72 x 10 ⁵ m ²)

¹ Coalbed methane emissions for the Mulberry coal seam (Tedesco, 2003).

3.5.4. Mine D: Hume Mine. Continental Coal Company's Hume Mine is located in Bates County in Missouri. It started operating in 2000 and produces about 62,000 tons of bituminous coal, annually. The mine uses dozers, excavators, front-end loaders and trucks. The mine exploits the Mulberry coalbed with a mineable seam averaging 35 inches in thickness, covered with about 56 ft thick overburden. Processing involves crushing, sizing and removal of non-coal material in a 120 ton/hour capacity portable crushing facility. The mine operates one 8-hour shift per day for six days in week. General parameters for the mine are in Table 3.5.

Table 3.5. General parameters for Hume Mine (Oswego Coal, 2008)

PARAMETER	VALUE
Average coal seam thickness	35 inches (0.89 m)
Average overburden thickness	56 ft (17.1 m)
Energy content	10,700 Btu/lb (24,888 MJ/tonne)
Ash content	15.9%
Sulfur	3.5%
Coalbed methane ¹	1.49 lb/ton (0.75 kg/tonne)
Annual production	62,000 tons (56, 000 tonnes)
Reserves	Total Reserves: 1.8 million tons (1.6 million tonnes) 0.52 million tons (0.47 million tonnes) mined through Oct. 2008. 1.25 million tons (1.13 million tonnes) left as at Nov. 2008.
Permit land area	Total permit area: 651 acres ($2.63 \times 10^6 \text{ m}^2$) Coal mining area: 460 acres ($1.86 \times 10^6 \text{ m}^2$) Facilities: 29.7 acres ($1.20 \times 10^5 \text{ m}^2$) Non disturbance area: 161.3 acres ($6.53 \times 10^5 \text{ m}^2$)

¹ Coalbed methane emissions for the Mulberry coal seam (Tedesco, 2003).

3.6. PRODUCT SYSTEM AND SCOPING

This study explored major processes linked to the production of coal from a surface mine. The processes covered included those within the mining lease area, such as exploration, mine development, and the operational phase activities (coal extraction, coal processing and land reclamation), as well as upstream processes for supplying material and energy inputs.

3.6.1. Functional Unit. In this study, the functional unit was defined based on mass, rather than energy. A mass-based functional unit is easy to work with since mining companies typically report their reserves and production information on the basis of mass. Also, the practice in the mining industry is that material inputs, waste products and economic information are expressed on the basis of a unit mass of product (typically a ton or tonne). Applying a mass basis provides clarity, easy comparability of LCA results and also allows for scaling of results over any production scale or time period of interest. The functional unit for this study was defined as, '*one tonne of processed coal at the mine gate*'. This choice of functional unit ensures consistency with the functional units used in many other coal LCA studies.

3.6.2. Selection of System Boundaries. Trying to collect all the data for all the unit processes connected to coal is impractical because of time and resource limitations. As a result, the system boundaries for the LCA had to be scoped to ensure a manageable volume of data within the constraints of available resources. The system under study is a cradle-to-gate system, which results in processes downstream of mining, (i.e. coal transportation to places of use, the use of coal and disposal of any end use waste products, such as fly ash), being excluded from the system boundaries. The initial system boundaries model before scoping (Figure 3.2) was drawn up by including all the processes that are believed to be significant in coal mining, specifically for the impact categories of energy use, climate change, resource depletion, water use and land use.

In the selection of system boundaries, care had to be taken to ensure that the critical environmental flows in the life cycle of coal were not excluded. Two steps were used for the selection of inputs and unit processes to include in the system boundaries. The first step was to determine if the inputs or unit processes contribute significantly to

impact categories that can be characterized on a local level or global scale. The second step was to apply quantitative methods to the unit processes in the model (Figure 3.2) to select those that are likely to be of significance to the respective impact categories.

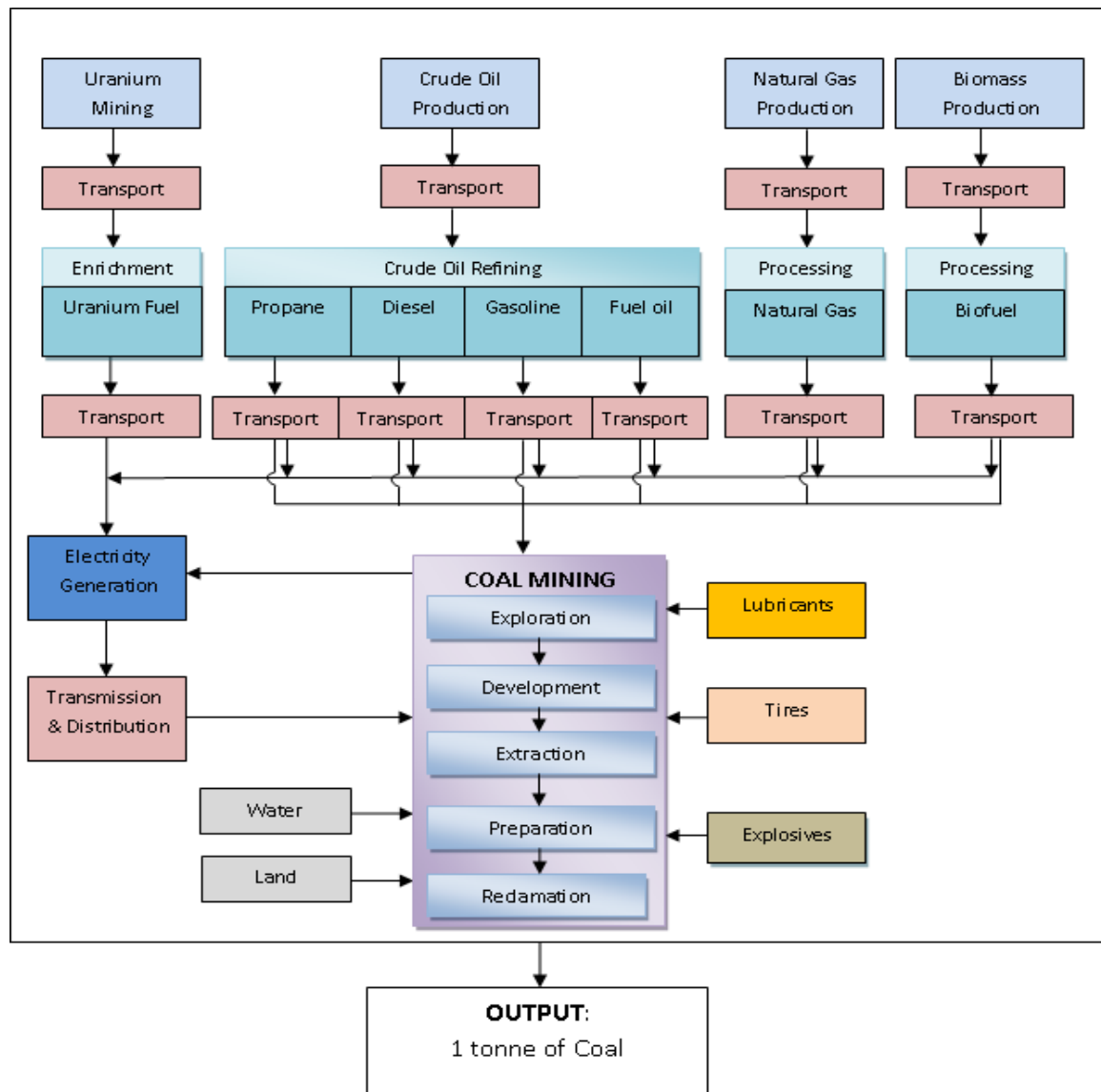

Figure 3.2. Initial product system model for cradle-to-gate assessment

3.6.2.1 Step No. 1. Trying to characterize water use and land use impacts on a global scale has presented challenges in LCA. This is because issues of scarcity of and

competition for use of water and land tend to be more relevant locally rather than globally, and therefore aggregating water use and land use across different regions is likely to lead to controversial results. Thus, it is justified to assess potential land use and water use impacts from coal mining activities in the context of the local situation, wherein the mine is located. So, in this LCA study, these impact categories were assessed by considering activities within the mining permit area only, because upstream unit processes are outside the lease area, and therefore do not have an impact on water and land use within the mining area (no local contribution). On the other hand, the impacts related to energy use (climate change and resource depletion), are global in nature, justifying that such impacts could be aggregated irrespective of where the different unit processes are located, spatially. So, the unit processes for material and energy inputs were considered for inclusion irrespective of where they occur.

3.6.2.2 Step No. 2. In this step the selection of unit processes is done using quantitative methods. Due to the differences in the nature of energy use and related impacts, water use and land use impacts, different criteria were used for selection of unit processes important for each.

3.6.2.2.1 Selection of Boundaries for Land Use and Water Use. With the assessment of land and water use restricted to the mining permit area, the next step was to select processes within the mine permit area which contribute significantly to these impacts. Water use from exploration stages, and mine development were disregarded as they are likely to be insignificant on a functional unit basis, compared to the operational phases of the mine. These are capital unit processes and are routinely disregarded in LCA studies (Baumann and Tillman, 2004). The available data on water consumption was presented as an aggregated figure for all mine processes, and this rendered the need for a cut off value unnecessary.

All stages of mining, from exploration, mine development, coal extraction and processing, to reclamation, were considered for land use impacts. The cut-off was set at 0.01% of the total potential land disturbance area within the mine lease area. The total potential land disturbance was determined by adding together the area disturbed by exploration, the area occupied by facilities and the coal resource area. The data for Mines A1 and A2 (Table 3.6) was used to determine activities to include and exclude in the

assessment. It was determined that land disturbance from exploration activities (0.0048%) was insignificant compared to the overall land disturbance, and so it was eliminated. In addition to the footprint of exploration being relatively small in size, the sites disturbed by exploration activities within a mining permit area, are likely to be covered under coal resource area, so that the elimination of exploration reduces chances of double counting.

Table 3.6. Land disturbance activities at Black Mesa and Kayenta complex

Activities in lease area	Area affected (acres)	Percent of lease area (%)
Exploration (Drilling pads)	1.9	0.005
Mine development (Facilities)	1,680	4.3
Coal extraction (Coal resource area)	37,240	95.7
Total Potential disturbance area	38,922	100

3.6.2.2.2 Selection of Unit Processes for Energy Sources. In the scoping of unit processes related to material and energy inputs, production and installation of capital goods were excluded from the system model as is the practice in LCA. Thus, energy use and material inputs in exploration, mine development, manufacture of mining equipment, processing plants, buildings and other equipment were excluded because it is expected that such processes would only have marginal impacts when their impacts are spread out over the coal reserves in the mines. Therefore, in the LCA, only material and energy inputs and emissions for the operational phase were considered. The unit processes for material and energy sources were selected using the Relative Mass-Energy-Economic (RMEE) method proposed by Reynolds et al. (2000). This method is specific to energy sources, which makes it applicable to coal. In the method, the relative mass, energy and economic value of a unit process product or input is used as a measure of the significance of its potential contributions to life cycle impacts. In the RMEE method, pre-set ratios of a unit process product's mass, energy and economic value to those of the functional unit are used to determine streams that could be excluded or included.

To establish the cut-off criteria, the energy content and spot price for coal from the Illinois coal basin (EIA, 2010) were used as they represent the averages for the coals produced from the mines in this study. Reasonable cut off-ratios were selected to ensure that unit processes of great importance to mining were not excluded. The cut-off ratios were set at 0.01% for mass, energy and economic value (Table 3.7).

Table 3.7. Cut-off criteria used in the RMEE scoping

Parameter	Value	Cut-Off Ratio (0.01%)	Remarks
Mass	1 tonne	0.0001 tonne	Bituminous coal
Energy content ¹	27,695 MJ	2.8 MJ	Illinois basin coal
Economic value ¹	\$ 49.23	\$ 0.005	Illinois basin coal spot price

¹ Illinois basin coal energy content of 11,800 Btu/lb and 12/31/2009 spot price of \$44.65/ton (EIA, 2010)

To enable drawing up of the system boundaries, data for Mines A1 and A2 was used to determine unit processes to include and exclude from the system boundaries. This was because the mine complex has data that covers more unit processes due to the use of more energy sources than the other mines in this study. Tires were eliminated from the system boundaries because of a lack of data on tire consumption in the mines. Uranium and biomass amounts were calculated based on electricity consumption at the mine complex using the share of the energy sources in the 2005 US generation mix from the Emissions & Generation Resource Integrated Database model, eGRID2007, version 1.1 (19.3% for nuclear and 1.3% for biomass) (EPA, 2009). Uranium in reactors is estimated to have an energy intensity of 8.7 MWh/g of U-235 (Argonne, 2009). Lubricant mass and economic value were based on a consumption rate of 0.018g/bhp.hr (DOE, 2004) and an estimated cost of \$4.00/L. Biomass parameters were based on 8600 Btu/lb dry biomass with a cost of \$1.25 per MMBtu contained in biomass (EIA, 2001). The economic values for electricity and fuels were Mine Cost Service estimates for March 2009 (InfoMine, 2009). The parameters used in the unit process selection for explosives were based on

energy content of 803.6 kcalories/kg ANFO (Aimone, 1992) and a price of \$48.00 per 100 lb ANFO (InfoMine, 2009). Based on the set cut-off ratios, the unit processes for lubricants, uranium and biomass were eliminated (Table 3.8). So, the boundaries of the product system model were redrawn to include only those unit processes with flows above the cut-off ratios (Figure 3.3).

Table 3.8. Scoping of unit processes for energy sources and material inputs

Unit Process Product	Mass Cut-off (kg)	Energy Cut-off (MJ)	Economic Value Cut-off (\$)
Cut off value	0.1	2.8	0.005
Electricity (12.84 kWh)	-	46.2	0.50
Diesel (2.71 L)	2.30	106.3	1.10
Gasoline (0.16 L)	0.12	5.3	0.11
Propane (0.323 L)	0.16	7.6	0.16
Explosives - ANFO (1,814g)	1.8	6.1	1.92
Lubricants ¹	0.0084		0.036
Tires ²	-	-	-
Uranium ¹ (2.47 kWh)	0.000019	8.9	-
Biomass ¹ (0.16 kWh)	0.084	1.7	0.002

¹ Unit process product excluded from product system using cut off ratios

² Unit process product eliminated from product system due to a lack of data.

3.6.2.2.3 Consolidation of Unit Processes. The Greenhouse Gases, Regulated Emissions, and Energy Use in Transportation (GREET) model, version 1.8c.0, developed by DOE's Argonne National Laboratory (Argonne, 2009), was used to trace electricity and fuels back to their primary energy sources. The model allows for evaluation of Well-To-Pump (WTP) energy inputs and emissions, giving aggregated results for the energy

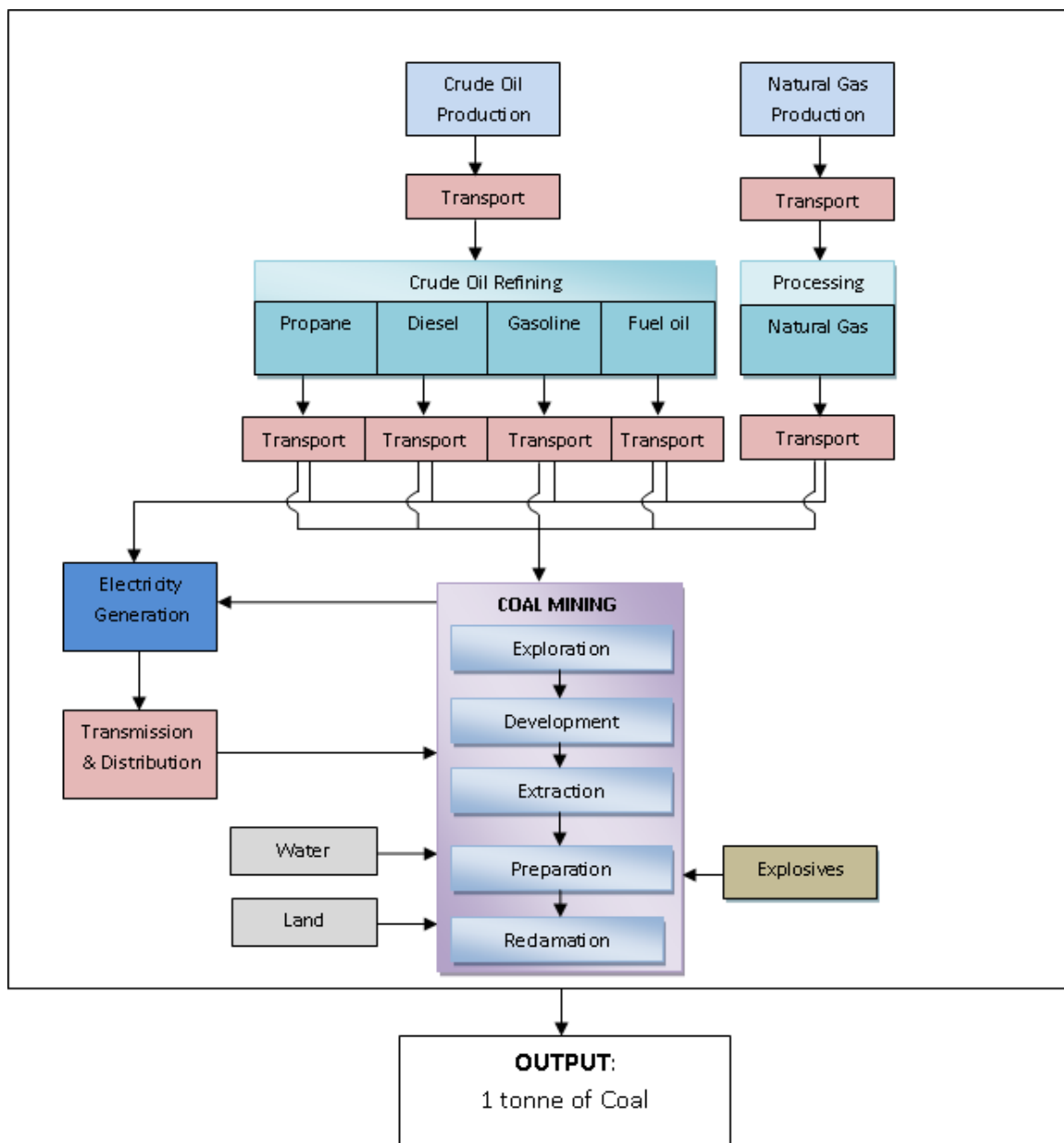

Figure 3.3. Product system model after scoping

inputs and associated gaseous emissions, from extraction of primary energy sources (coal, petroleum, natural gas, biomass), through refining and production of useable fuels or generation of electricity, to delivery of fuels or electricity to the fuel station pump (place of use). Also, data for some processes within the mining lease area were available as aggregated figures, and in some cases it was difficult to divide and assign data to the

individual mining processes without the risk of introducing uncertainty in the data. So, these connected unit processes for which a single data point exists were consolidated into one equivalent process. The “equivalent unit process” representing several unit processes brought together is identified by the double line boundary box in the final system boundaries (Figure 3.4).

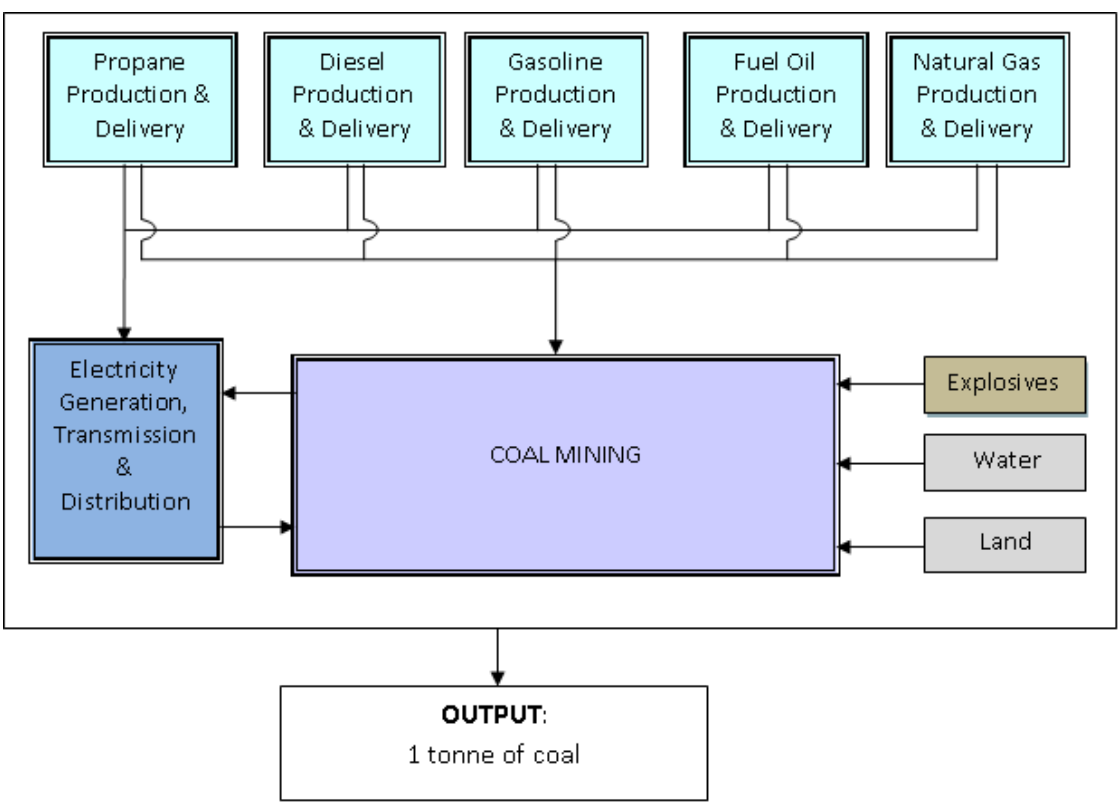

Figure 3.4. Final system boundaries after scoping and consolidation

4. LIFE CYCLE INVENTORY ANALYSIS

Data on water use, land area use, and energy production and consumption, as well as greenhouse gas emissions associated with energy use and those from geological formations (coalbed methane) had to be sourced or calculated in order to compile life cycle inventories for the mines. The environmental flows were calculated per functional unit for all the unit processes shown in the final system boundaries (Figure 3.4).

4.1. WATER USE

Data of interest was on water consumption for all the processes related to coal mining within the permit areas. However, data could not be sourced for most of the case study mines. Only Mines A1 and A2 had data available on water consumption. The data was presented as an aggregated figure, and not broken down according to the different uses in the mines.

4.2. LAND USE

The land surface area that can potentially be disturbed in the life of a mine was determined from coal resource area and area occupied by development of facilities (processing plants, workshops, office building, access roads, stockpiles, impoundment structures, and other structures associated with the operation). Land use calculations for the life cycle inventory analysis were determined by dividing the total land area that is likely to be disturbed throughout the life of a mine (land already disturbed by construction of facilities and coal extraction, plus coal resources areas that are yet to be disturbed) by the total reserves for the mine. Table 4.1 summarizes the land disturbances for the mines.

Table 4.1. Land area disturbance by mine

	Mines A1&A2	Mine B	Mine C	Mine D
Lease area (acres)	64585	895.1	694	651
Coal extraction area (acres)	37240	548.7	560	460
Facilities area (acres)	1680	105.6	42	29.7
Non disturbance area (acres)	25665	240.8	92	161.3
Total disturbance area (acres)	38920	654.3	602	489.7
Coal Reserves (million tons)	807	7.7	1.5	1.77
Disturbed acres/ton	4.82×10^{-5}	8.50×10^{-5}	4.01×10^{-4}	2.77×10^{-4}
Disturbed m ² /tonne coal	0.215	0.379	1.79	1.23

4.3. COALBED METHANE EMISSIONS

Besides GHG emissions from energy use, methane from strata is another important contributor to climate change impacts. The data on coalbed methane emissions for Mines A1 and A2 was sourced from the EIS for the mines (OSMRE, 2008), while the gas content for the Illinois coal basin (Kirchgessner, Piccot and Masemore, 2000) was used for Mine B and that for the Mulberry coal seam (Tedesco, 2003) was assumed for mines C and D since they are in the same coal basin.

4.4. ENERGY SOURCES

4.4.1. Electricity and Fuels. Data for consumption of electricity and fuels (diesel, gasoline and propane) in Mines A1 and A2 were sourced from the Environmental Impact Statement for the mines (OSMRE, 2008). The data selected for the mines were averages for 2004 and 2005, the years when both mines were operational. For the other mines (B, C and D) however, data on consumption of fuels and electricity were not

available, and so energy use had to be estimated based on the major equipment used in the mines and the operating schedules.

The estimation of diesel use was based on the equipment make, model and capacity. The data on power ratings, load factors, fuel consumption rates were obtained from the Caterpillar Performance Handbook (Caterpillar, 2008) and other Original Equipment Manufacturer (OEM) specifications and manuals for the specified equipment. The power ratings and fuel consumption rates for lighting plants and associated generators, bulk explosives trucks, maintenance and welding trucks, lube trucks, fuel trucks and water trucks were estimated from the Mining Costing Service's Equipment Estimator's Guide (InfoMine, 2009). To avoid under estimation of diesel use in the operations, the highest load factor ranges and the associated fuel consumption rates were used. For all equipment, an operating efficiency (availability and utilization) of 85% was assumed, and the diesel consumptions were calculated based on the scheduled operating hours for each mine.

Estimations of gasoline consumption for gasoline trucks (crew cabs) for Mines B, C, and D were obtained from the GREET model, version 1.8c.0 (Argonne, 2009). The Well-To-Wheel modeling was used to estimate the energy consumed per mile during the operation of a light duty truck. The energy was converted to gasoline volume using a fuel economy of 19.7 miles per gallon for light duty trucks as used in the model. It was assumed that each vehicle travels an average of 50 miles per 8-hour shift.

Due to the limited information on electrical equipment used at the mines, estimates of electrical power consumption for Mines B and D were based on the rated production capacities of the coal processing plants while that for Mine C was based on the rated power of the internal combustion diesel generator that is used to provide electricity on site. Using the raw tons per hour rating of the plants, the power rating of the processing plants were estimated from the InfoMine's Mining Costing Service. Annual power consumptions for the plants were calculated using the number of hours required to meet the annual production for each mine, assuming 100% utilization of plant capacity and 5% coal loss from processing. The annual power consumption for Mine C was based on 90% of the rated power of the diesel generator and the scheduled number of the hours

in a year. Table 4.2 presents the consumption of electricity and fuels for the mines based on a tonne of coal produced.

Table 4.2. Energy consumption in the different mines per tonne of coal produced

	Mines A1&A2	Mine B	Mine C	Mine D
Electricity (kWh)	12.84	1.60	2.62	2.34
Diesel (Liters)	2.71	10.72	13.67	21.02
Gasoline (Liters)	0.16	0.17	0.23	0.17
Propane (Liters)	0.323			

The emissions of greenhouse gases from the use of fuels including diesel, gasoline and propane were calculated using the carbon content, oxidation factors and emission factors for the fuels as determined by EPA (EPA, 2005). The volume of fuel used per tonne of coal (Table 4.2) was used to calculate the amount of greenhouse emissions and the results are as summarized in Table 4.3.

The GREET model was used to model the Well-To-Pump (from extraction of primary fuels to delivery of fuels and electricity to place of use) energy consumption and associated greenhouse gas emissions. For preservation of the temporal aspects of the energy use data, the modeling was run for the base year 2005. In the modeling of fuels, it was assumed that the mines use conventional motor gasoline and diesel fuel with no blends of biofuels.

Unless there was available information indicating that a mine generates its own electricity on site, it was assumed that the mine was connected to the grid. To model the energy consumption and emissions associated with the generation and delivery of grid electricity to a particular mine, the generation resource mix for the state in which the mine is located was used in the GREET model. The state generation resource mix was used instead of the national resource mix to make the data as specific as possible to each operation. The 2005 State generation resource mixes from the eGRID2007 model (EPA, 2009) were used (see Table 4.4). The model assumes electricity transmission and distribution losses amount to 8% of power plant output. The amount of primary energy

sources and total energy input necessary for Well-To-Pump delivery of electricity and fuel to the mines is shown in Table 4.5 while the GHG emissions associated with the same processes are shown in Table 4.6.

Table 4.3. GHG emissions from fuel use in the mines based on 1 tonne of coal

		Mines A1&A2	Mine B	Mine C	Mine D
Diesel Use	CO ₂ (g)	7,219.98	28,560.23	36,419.63	56,001.50
	CH ₄ (g)	0.000	0.000	0.000	0.000
	N ₂ O (g)	0.000	0.000	0.000	0.000
Gasoline Use	CO ₂ (g)	371.49	394.71	534.01	394.71
	CH ₄ (g)	0.000	0.000	0.000	0.000
	N ₂ O (g)	0.000	0.000	0.000	0.000
Propane Use	CO ₂ (g)	0.62			
	CH ₄ (g)	0.000			
	N ₂ O (g)	0.000			
Totals: All Fuel Types	CO ₂ (g)	7,592.09	28,954.94	36,953.64	56,396.21
	CH ₄ (g)	0.000	0.000	0.000	0.000
	N ₂ O (g)	0.000	0.000	0.000	0.000

Table 4.4. The 2005 eGRID generation resource mixes for the US and three States

	US	Arizona	Illinois	Missouri
Coal (%)	49.61	39.56	47.52	85.23
Oil (%)	3.03	0.04	0.17	0.19
Gas (%)	18.77	28.48	3.66	4.29
Other fossil (%)	0.60	0	0.12	0.08
Biomass (%)	1.30	0.06	0.35	0.01
Hydro (%)	6.50	6.41	0.07	1.37
Nuclear (%)	19.28	25.43	48.03	8.84
Wind (%)	0.44	0	0.07	0
Solar (%)	0.01	0.01	0	0
Geothermal (%)	0.36	0	0	0
Other unknown fuel (%)	0.10	0	0	0

Table 4.5. Primary energy inputs for delivery of electricity and fuels to the mines based on 1 tonne of coal produced

		Mines A1&A2	Mine B	Mine C	Mine D
Electricity generation and delivery	Consumption (kWh)	12.84 ¹	1.60 ¹	2.62 ²	2.34 ¹
	Coal (g)	33,678.5	4,636.9		14,703.1
	Natural Gas (g)	22,705.5	345.5		705.7
	Petroleum (g)	602.8	87.1		239.0
	Energy input (Btu)	66,255.2	6,706.9		16,252.2
Diesel production and delivery	Consumption(L)	2.7	10.7	13.7	21.0
	Coal (g)	2,981.7	11,794.6	15,040.4	23,127.2
	Natural Gas (g)	7,055.2	27,908.4	35,588.4	54,723.3
	Petroleum (g)	7,599.8	30,062.8	38,335.7	58,947.8
	Energy input (Btu)	17,961.4	71,050.3	90,602.3	139,316.8
Gasoline production and delivery	Consumption(L)	0.2	0.2	0.2	0.2
	Coal (g)	207.4	220.3	298.1	220.3
	Natural Gas (g)	417.6	443.7	600.3	443.7
	Petroleum (g)	501.8	533.2	721.3	533.2
	Energy input (Btu)	1,214.1	1,290.0	1,745.3	1,290.0
Propane production and delivery	Consumption(L)	0.323			
	Coal (g)	76.4			
	Natural Gas (g)	538.9			
	Petroleum (g)	203.0			
	Energy input (Btu)	829.4			
Totals: All energy sources	Coal (g)	36,944.0	16,651.8	15,338.5	38,050.6
	Natural Gas (g)	30,717.2	28,697.6	36,188.7	55,872.7
	Petroleum (g)	8,907.4	30,683.1	39,057.0	59,720.0
	Energy input (Btu)	86,260.1	79,047.2	92,347.6	156,859.0

¹ - Electricity inputs include 8% for transmission and distribution losses along grid.

² - Electricity generated on site from internal combustion diesel generator and inputs included under diesel.

Table 4.6. GHG emissions for production and delivery of electricity and fuels to produce 1 tonne of coal

		Mines A1&A2	Mine B	Mine C ²	Mine D
Electricity generation and delivery	CO ₂ (g) ¹	8,421.657	962.852		2,471.463
	CH ₄ (g) ¹	13.042	1.119		2.803
	N ₂ O (g) ¹	0.114	0.011		0.025
Diesel production and delivery	CO ₂ (g)	1436.000	5680.600	7243.800	11138.600
	CH ₄ (g)	9.690	38.330	48.890	75.180
	N ₂ O (g)	0.023	0.092	0.117	0.180
Gasoline production and delivery	CO ₂ (g)	85.400	90.700	122.700	90.700
	CH ₄ (g)	0.560	0.595	0.805	0.595
	N ₂ O (g)	0.005	0.005	0.007	0.005
Propane production and delivery	CO ₂ (g)	63.768			
	CH ₄ (g)	0.822			
	N ₂ O (g)	0.001			
Totals: All energy sources	CO ₂ (g)	10,006.825	6,734.152	7,366.500	1,3700.763
	CH ₄ (g)	24.114	40.044	49.695	78.578
	N ₂ O (g)	0.143	0.108	0.124	0.210

¹ - Emissions include 8% for electricity transmission and distribution losses along grid.

² - Electricity generated from diesel generator and GHG emissions included under diesel.

4.4.2. Explosives. The assessment of energy and GHG emissions associated with explosives were limited to explosives use in the mines, due to a lack of data on the processes for making explosives and the main ingredients. To estimate energy use and emissions from blasting activities, it was assumed that all operations use ANFO. The amount of explosives necessary to expose a given tonnage of coal were based on the typical blast design parameters given for the operations, and where there were no blast parameters given, a powder factor of 0.026 lb/ft³ was assumed. The average overburden and inter-burden thickness as well as the coal seam thickness were used in the

determination of the amount of explosives required per tonne of coal. The energy content of 803.64 kcalories/kg ANFO as per Aimone (1992) and an emission factor of 0.17 tonnes CO₂ per tonne of ANFO detonated (Day et al., 2009) were used. The energy content and emissions from detonators and primers were disregarded as they would be insignificant in amount compared to ANFO used per hole. The explosives requirements per tonne of coal and the energy content as well as CO₂ emissions are presented in Table 4.7.

Table 4.7. Explosives energy and emissions per tonne of coal mined

	Mines A1&A2	Mine B	Mine C	Mine D
Powder factor (lb/ft ³)	0.026*	0.026*	0.026	0.023
Amount ANFO (g)	1,814	4,241	6,914	4,656
Energy Content (Btu)	5,778	13,505	22,028	14,828
CO ₂ emission (g)	308.38	720.97	1,175.38	791.52

* - Powder factor assumed where blasting parameters not available.

4.5. LIFE CYCLE INVENTORY ANALYSIS RESULTS

To compile the inventories for the mines, the unit process environmental exchanges were summed together for each resource input or emission. The inventory analysis results for the mines are shown in Table 4.8.

Table 4.8. Inventory analysis results for the different mines.

	MINES A1&A2	MINE B	MINE C	MINE D
INPUTS FROM TECHNOSPHERE				
Electricity (kWh)	13.96	1.75	2.62	2.54
Diesel (L)	2.71	10.72	13.67	21.02
Gasoline (L)	0.16	0.17	0.23	0.17
Propane (L)	0.32			
Explosives (ANFO) (kg)	1.81	4.24	6.91	4.66
INPUTS FROM NATURE				
Total Energy Input (MJ)	97	98	121	181
Coal (kg)	1,036.94	1,016.65	1,015.34	1,038.05
Natural Gas (kg)	30.72	28.70	36.19	55.87
Petroleum (kg)	8.91	30.68	39.06	59.72
Water (L)	178.00			
Land area (m ²)	0.22	0.38	1.79	1.23
GHG EMISSIONS TO AIR				
CO ₂ (g)	17,907.30	36,410.06	45,495.52	70,888.49
CH ₄ (g)	797.61	697.85	793.70	822.58
N ₂ O (g)	0.14	0.11	0.12	0.21
PRODUCT OUTPUT				
Bituminous Coal (tonnes)	1.00	1.00	1.00	1.00
Energy Content (MJ/tonne)	29,784	28,337	25,353	24,888

5. LIFE CYCLE IMPACT ASSESSMENT

In this chapter, the inventory analysis results are translated to contributions to the selected environmental impact categories. The impact assessment results are compared for the mines in the study. Sensitivity analysis is conducted for some impact categories to identify unit processes and factors, which are critical to the LCA results. Data quality and uncertainty issues are addressed, then improvement recommendations to address dominant sources of impacts are advanced.

5.1. ASSESSMENT OF IMPACTS

In this study, the life cycle impacts were assessed for the categories of water use, land use, energy use, abiotic resource depletion and climate change. The dominant sources of impacts were identified for further analysis. To avoid problems of ambiguity in the LCA results, the mandatory steps of LCIA (classification and characterization) were used, and the optional steps of normalization, grouping and weighting, which typically are subjective, were omitted. However, the optional step of data quality analysis was included because of its importance in explaining the significance of LCA results for appropriate interpretation and conclusions. Where characterization factors were used, to assure confidence in the LCA results, the use of damage-oriented (end-point) characterization models was avoided because of their high levels of uncertainties due to limited scientific data. Mid-point characterization models were preferred.

5.1.1. Water Use Impacts. No characterization factors were used for water use impacts, because currently there are no characterization methods standardized in LCA methodology for this impact category. Water consumption from the inventory analysis phase was used as an indicator for water use impact. Water use impact was evaluated for Mines A1 and A2 only, as there was no data available to this research for the other mines. Water use impact was determined to be 178 liters per tonne of coal produced.

5.1.2. Land Use Impacts. Trying to characterize land use impacts from the transformative perspective, considering parameters such as shifts in competition between land uses, and changes in quality, productivity and biodiversity, is complex and not

practical because of the array of data that would need to be collected (Baumann and Tillman, 2004). In this study, life cycle land use impacts were assessed from the occupancy perspective in which the area and duration of occupation are accounted for. Using this approach in the context of current surface coal mining practices does not ignore the land quality, as the restoration element of reclamation is taken into account.

The formula used for land occupation impacts is derived from the original formula by Lindeijer (2000), which gives land occupation impact as:

$$LOI = AtQ \quad (1)$$

where;

LOI is the land occupation impact.

A is the area of occupied land.

t is the duration of time before the land quality is restored.

Q is the initial quality of land before impact. [Note: Lindeijer (2000) allows for land to be restored to quality other than the original].

Spitzley and Tolle (2004) suggest that the quality term (*Q*) in the original formula can be dropped if the land could be restored to the original quality after mining. Since the regulations of the Surface Mining Control and Reclamation Act (SMCRA) of 1977 require coal mine sites to be reclaimed to original use or better, the assertion by Spitzley and Tolle (2004) can be assumed to be reasonable. Equation (2) is the resulting equation proposed by Spitzley and Tolle (2004).

$$LOI = At \quad (2)$$

To take into account the cumulative impacts over years as disturbances due to mining activities progress and land is restored to the desired quality by reclamation activities, the formula for land occupation impacts per functional unit can be modified to the following:

$$LOI = \frac{1}{R} \sum_{t=1}^T (A_d^t(T-t) - A_r^t) \quad (3)$$

where;

A_d^t is the land area disturbed during year t .

A_r^t is the reclaimed area that is ready for release of bond during year t .

T is the total number of years from the beginning of the mine to the release of the final reclamation bond.

R is the total reserves in tonnes.

In this study, it was assumed that the reclaimed land reaches desired quality for reclamation bond release five years after the initial revegetation for mines in Missouri and Illinois (Mines B,C, D), and 10 years for mines in Arizona (Mines A1 and A2) as per the SMCRA regulations. Also, the calculations on land use impacts were based on the assumption that reclamation was equally successful for the land impacted by coal extraction activities and that impacted by mine facilities. Where year by year data on areas already mined and areas reclaimed were not available, the total coal resource areas disturbed and reclaimed were divided among the years based on annual production rates. Also, all the areas occupied by facilities were assigned to the first year of operation. The current production rates were used to estimate future annual disturbance rates and it was assumed that the same amount of area was reclaimed as was disturbed in a year. It was further assumed that all the land not reclaimed on the year of exhaustion of coal resources, was reclaimed and revegetated within 2 years of exhaustion of coal, except for Mine D (Hume) for which reclamation and revegetation is to be done within a year of cessation of coal extraction. The results of the assessment of potential land use impacts for the mines are shown in Table 5.1.

Mine C, which has the largest land area disturbance of 1.8 m²/tonne (see Table 4.1), also has the highest potential land use impact of 10 m²-year/tonne of coal produced, followed by Mine D with area disturbance of 1.2 m²/tonne (Table 4.1) and a potential impact indicator of 9 m²-year/tonne.

Table 5.1. Land use impacts per tonne of coal produced

	Extraction (m²-year)	Facilities (m²-year)	Total (m²-year)
Mines A1 & A2	4.1	0.8	4.9
Mine B	1.9	1.0	2.9
Mine C	8.4	1.6	10.0
Mine D	6.4	2.5	9.0
Average	5.2	1.5	6.7

The high potential land use impacts for the two mines can be linked to their relatively high stripping ratios of 22:1 for Mine C and 19:1 for Mine D, as well as their small scales of production. The small scale of production leads to prolonged life of the mine, and hence a lengthened duration of land occupation, but only for a small coal reserve. Mine B has the lowest potential for land use impact, with an impact indicator of about 3 m²-year/tonne, and this may be explained by the better stripping ratio (14:1), the bigger scale of production, and the smaller footprint for facilities, compared to Mines C and D. On the other hand, Mines A1 and A2, which have the highest production capacity of the case study mines, the most favorable stripping ratio of 6:1, and hence the smallest disturbance footprint (0.22 m²/tonne), have a higher potential land use impact than Mine B, at 5 m²-year/tonne. The higher land use impact relative to the land disturbance area for Mines A1 and A2 can be attributed to the slow recovery time for vegetation, following reclamation, due to the arid climate in the region, which necessitates 10 years for reclamation bond release. The average land use impact for all the mines is about 6.7 m²-year/tonne.

Figure 5.1 shows the comparisons, for each mine, of contributions to land disturbance area and land use impacts (land occupation) by coal extraction activities and mine facilities. Coal extraction dominates both the land disturbance area, as well as the land use impacts for all the mines. However, the proportion of contribution to land use impacts by coal extraction is lower compared to the proportion of area disturbed by the same. Per unit area disturbed, mine facilities have a higher land use impact potential than coal extraction. This is due to the extended duration of land occupation by facilities, (typically from mine development stage up to cessation of mining operations), while

mined out coal resource areas are usually reclaimed concurrently with coal extraction in other pits. However, this is only valid under the assumption that reclamation efforts on coal extraction areas and areas affected by mine facilities are equally successful. On average, for all the mines, mine facilities contribute 22% towards the land use impacts and coal extraction areas contribute 78%.

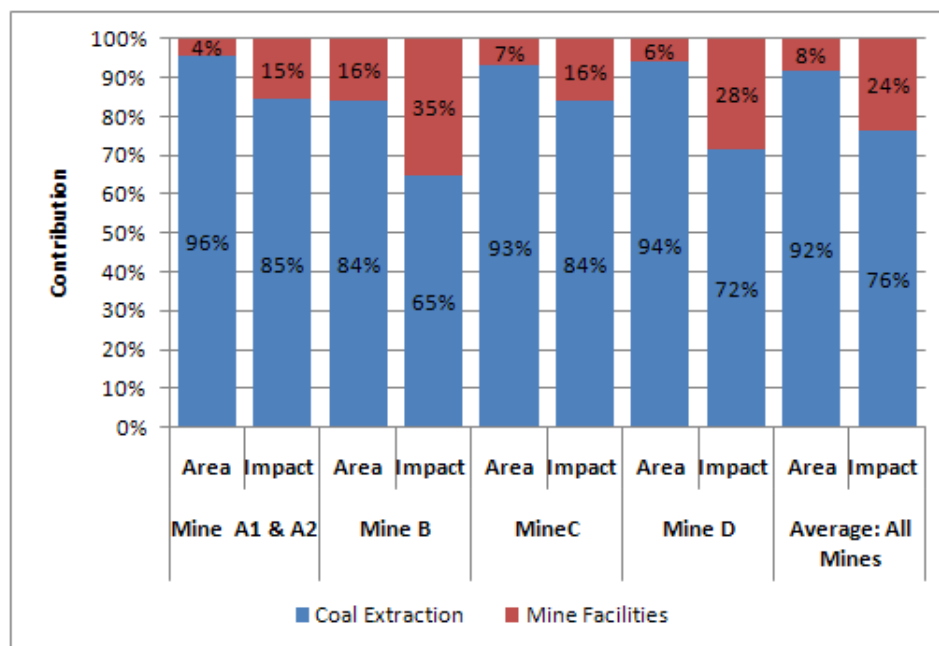

Figure 5.1. Contributions to area disturbance and land occupation impacts

5.1.3. Energy Use Impacts. This impact category assesses the total energy used to produce a tonne of coal at the mine gate. This study used energy intensity values as indicators for energy use impacts. The potential energy use impacts based on the inventories for the mines are shown in Table 5.2. The proportions of contributions to impacts by different energy sources are shown in Figure 5.2

The assessed potential energy use impacts are 97 MJ/tonne for Mines A1 and A2, 98 MJ/tonne for Mine B, 121 MJ/tonne for Mine C and 181MJ/tonne for Mine D. The biggest contributor to potential energy use impact for Mines A1 and A2 is electricity use, which makes up 72% of the impact (see Figure 5.2), while the impact indicators for the other mines are dominated by diesel use, which makes up 77% for Mine B, 79% for

Table 5.2. Energy use impact indicators for the mines

	Energy Use Impact Indicators (MJ)				
	Mines A1&A2	Mine B	Mine C	Mine D	Average
Electricity	69.9	7.1	-	17.1	31.4
Diesel	19.0	75.0	95.6	147.0	84.1
Gasoline	1.3	1.4	1.8	1.4	1.5
Propane	0.9	-	-	-	0.2
Explosives	6.1	14.2	23.2	15.6	14.8
Total (MJ/tonne)	97.1	97.6	120.7	181.1	124.1

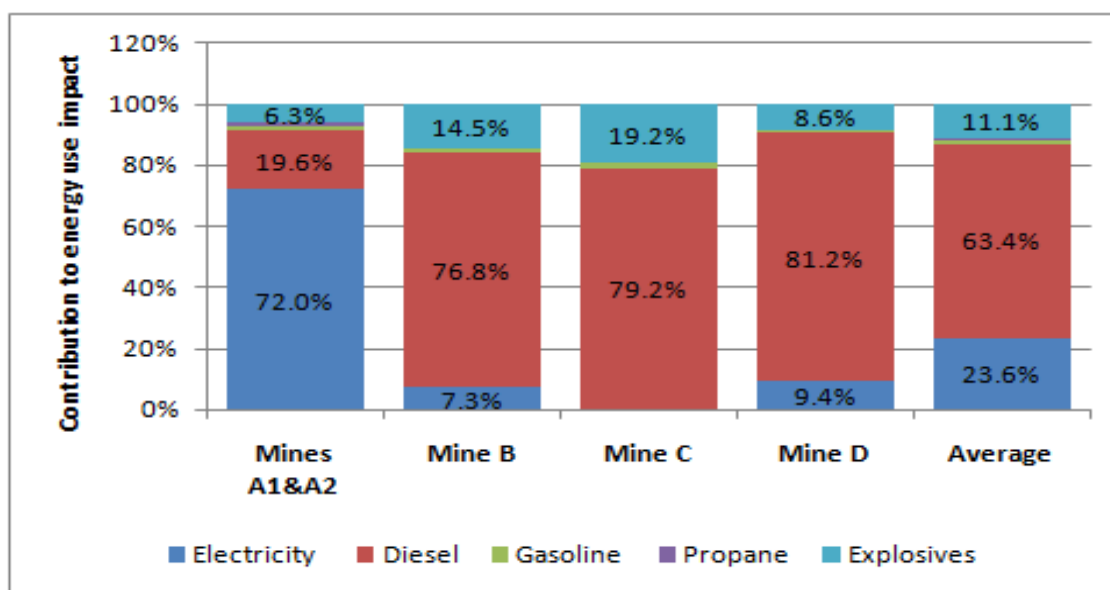

Figure 5.2. Contributions to energy use impacts by different energy sources

Mine C, and 81 % for Mine D. The contributions from explosives use, which vary from 6% for Mines A1 and A2, to a maximum of 19% for Mine C, reflect the differences in stripping ratios for the mines. The energy use impacts due to gasoline and propane use are only marginal (maximum of 1.5% for gasoline and 0.9% for propane). The average potential energy use impact for all the mines is 133 MJ, with 63% of the impacts being contributed by diesel use, 24% by electricity use, 11% by explosives use, and the rest by gasoline and propane use.

Coal extraction and reclamation activities are the major contributors to energy use impacts, compared to other activities such as coal processing. This is reflected in the dominance of potential impacts by sources of energy connected with the prevalent earth moving equipment. For instance, Mines A1 and A2, which use large production units (draglines and shovels) that are electrically driven, have a big portion of their energy use impact associated with electricity. On the other hand, Mines B, C, D, which depend on smaller diesel equipment for earth moving, have their energy use impacts heavily influenced by diesel contributions.

Figure 5.3 shows the variations of energy use with the production scales for the mines. While differences in geological conditions (e.g. stripping ratios) and the extent of coal processing (which depends on the in-situ quality of coal and the quality desired by customers), determine the amount of energy required in the production of coal, it can be deduced from the trend in Figure 5.3 that, to some extent, the scale of production has an influence on the energy use impacts. The larger scales of production offer the benefits of better energy efficiencies, and this is reflected in the progressively lower potential energy use impacts as the scale of production increases from Mine D to Mines A1 and A2.

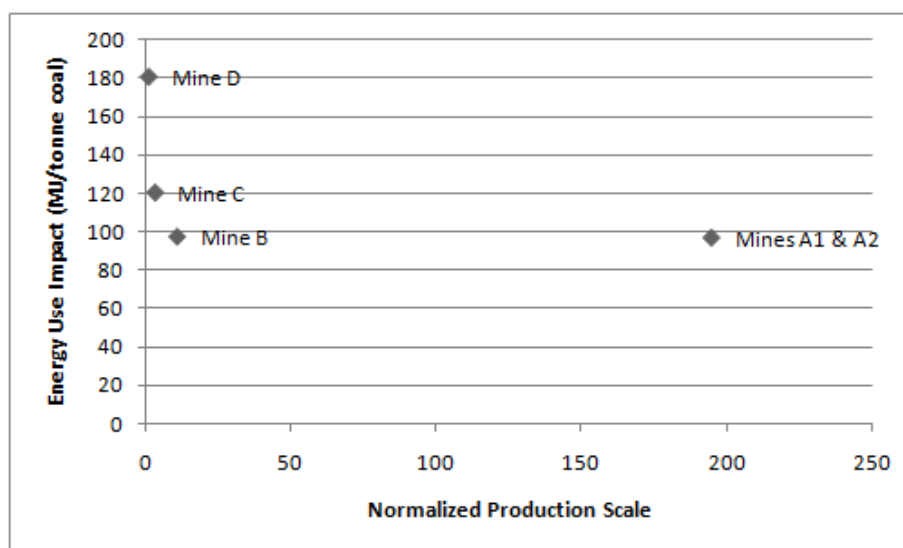

Figure 5.3. Potential energy use impact versus normalized scale of production.

A production scale is normalized by dividing the annual production rate for a mine, by the smallest production rate (62,000 tons for Mine D).

In their Mining Industry Energy Bandwidth Study (DOE, 2007), the Department of Energy (DOE) modeled energy use for hypothetical US coal mines that produce about 10,000 tons per day. The study estimates that a typical Western US surface coal mine has an energy intensity of 41,960 Btu per ton of coal (49 MJ/tonne), while a surface mine in the US Interior uses 69,746 Btu/ton (81 MJ/tonne). These figures appear lower than the energy use impacts assessed in this study, and this may be attributed mainly to the fact that the energy intensities are not life cycle energy consumptions, but rather, they are estimates of energy consumption directly in the operations. Further, the energy estimates pertain only to diesel equipment used for earth moving, and do not include other energy sources necessary for coal beneficiation and other processes in a mine.

Mangena and Brent (2006) evaluated energy use in real surface coal mines, and the values assessed spanned the impact indicators calculated in this work. They assessed an energy intensity of 46 MJ/tonne for a 11 million tonne-per-annum surface mine that produces low grade coal (the coal is crushed and screened, but it is not washed), and 219 MJ/tonne for a 4.4 million tonne/year mine which produces washed coal. Their study is a gate-to-gate assessment and it pertains to the South African situation (geological conditions, electricity generation resource mixes, petroleum refineries, and other parameters may be different). These estimates can only be compared to Mines A1 and A2 which produce 4.8 to 8.5 million tonnes per annum, with an energy intensity of 97 MJ/tonne.

5.1.4. Abiotic Resource Depletion Impacts. The abiotic resource depletion impact indicators relate life cycle inputs to the extraction of minerals and fossil fuels. The Center of Environmental Science of Leiden University (CML) has developed characterization factors, called Abiotic Depletion Potentials (ADPs), for different minerals and materials, including energy sources (Guinée, 2002). The CML 2001 characterization factors were used in this study. The ADPs (Table 5.3) are based on mid-point modeling and a standard of '*kg antimony equivalent/kg resource extraction*'. The characterization modeling is based on reserves and rates of extraction on a global scale. CML 2001 characterizes abiotic resource depletion by the formula:

$$\text{Abiotic Resource Depletion} = \sum_i (\text{ADP}_i \times m_i) \quad (4)$$

where;

ADP_i is the Abiotic Depletion Potential of resource i .

m_i is the quantity of resource i extracted to provide inputs for the life cycle system.

Table 5.3. CML 2001 Abiotic Depletion Potentials for fossil fuels (Guinée, 2002)

ABIOTIC RESOURCE	ADP – CML 2001
Soft coal	0.00671 kg Sb-eq./kg
Natural gas	0.0187 kg Sb-eq./m ³
Crude oil (petroleum)	0.0201 kg Sb-eq./kg

The assessment of resource depletion was characterized with respect to fossil fuels (coal, natural gas and crude oil) only, since they are the important energy sources in the life cycle of coal. While explosives contribute a significant amount of energy, they have not been included due to the lack of an appropriate characterization factor. The results of resource depletion impact assessment are shown in Table 5.4.

Table 5.4. Resource depletion impacts for the mines

	Resource Depletion (kg Sb-eq. Per Functional Unit)				
	Mines A1&A2	Mine B	Mine C	Mine D	Average
Coal	6.96	6.82	6.81	6.97	6.89
Natural Gas	0.67	0.62	0.79	1.21	0.82
Petroleum	0.18	0.62	0.79	1.20	0.70
Overall Resource Depletion Impact	7.80	8.06	8.38	9.38	8.41

The overall resource depletion impacts relate to the energy intensities for the mines. Mines A1 and A2, which have the lowest energy use impact (97 MJ/tonne) also have the lowest overall fossil energy resource depletion impact of 7.8 kg Sb-eq./tonne of coal. Their performance is followed by Mine B (98 MJ/tonne) with 8.1 kg Sb-eq./tonne and Mine C (121 MJ/tonne) with 8.4 kg Sb-eq./tonne. Mine D's high energy intensity of 181 MJ/tonne results in the highest resource depletion impact of 9.4 kg Sb-eq./tonne. The average potential abiotic depletion impact for all the mines is 8.4 kg Sb-eq./tonne of coal.

The contributions to the overall abiotic resource depletion impacts by individual fossil fuels (Figure 5.4) are determined by the energy source mixes for the different mines. Mines A1 and A2 have the lowest contribution to resource depletion impact from petroleum at 2%, and the highest contribution attributed to coal at 89%. This can be explained by the mines' low use of petroleum derived fuels (diesel, gasoline and propane) and heavy reliance on electricity generated, partly, from coal. The heavy use of diesel in Mines B, C, D, is reflected in their relatively higher resource depletion impact contribution from petroleum (8% of total resource depletion impact for Mine B; 9% for Mine C; and 13% for Mine D).

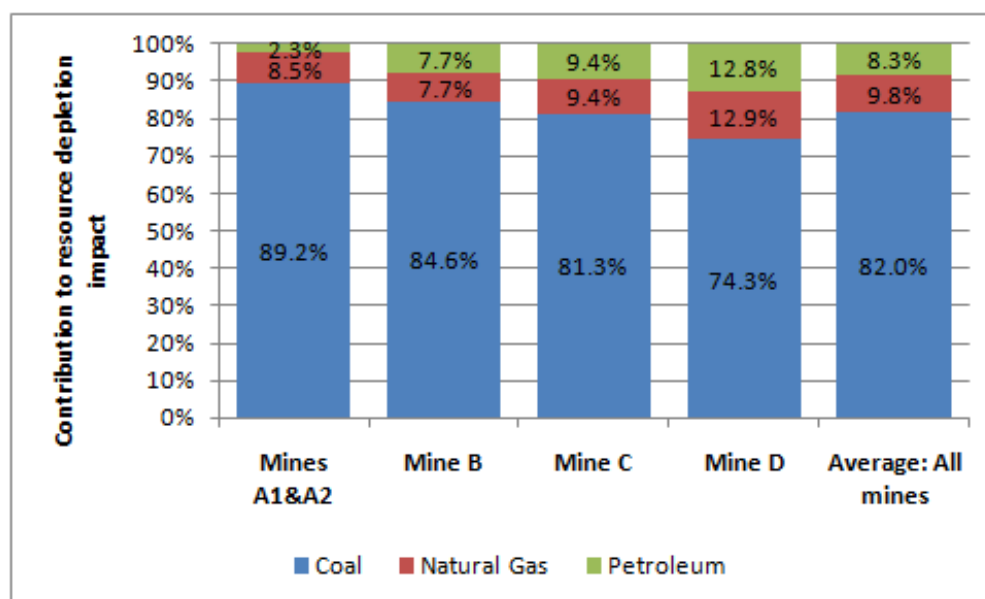

Figure 5.4. Contributions to abiotic resource depletion impacts by fossil fuels

As is the case with energy use, the abiotic resource depletion impacts are linked to the benefits of economies of scale as shown by the trend in Figure 5.5. Mines A1 and A2 which have the highest production scales, record the lowest potential resource depletion impact, followed by Mine B, and Mine C and Mine D, in the order of decreasing production scales.

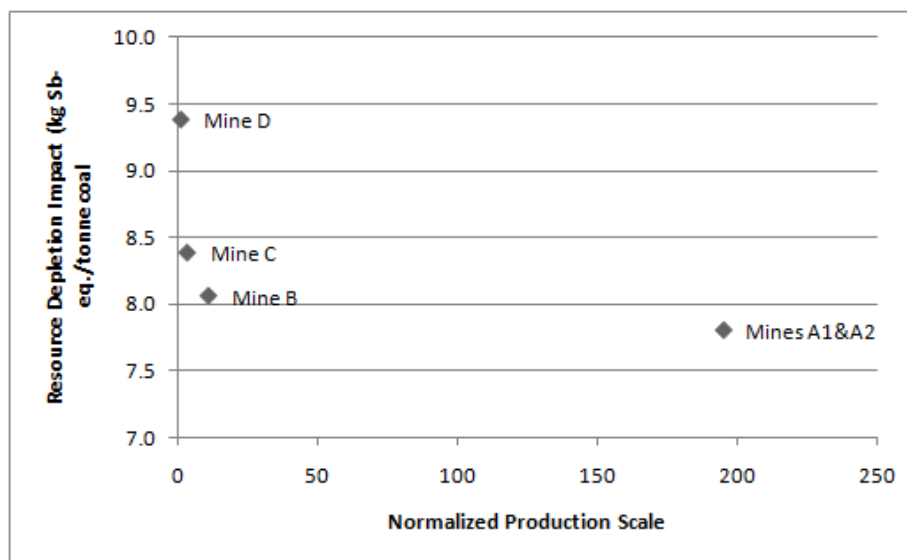

Figure 5.5. Resource depletion impact versus production scale

The mines do not use natural gas directly in the operations, so, the resource depletion figures for natural gas represent the use of the energy source in the pathways for producing and delivering different fuels and electricity to the mines. For instance, the higher proportion of natural gas depletion in relation to the overall resource depletion impacts indicators for Mines A1 and A2 (8.5%) compared to Mine B (7.7%), is due to the greater use of electricity at Mines A1 and A2, which is from a generation resource mix with a high natural gas component (28 % for Arizona), compared to only 3% natural gas in the generation resource mix for Illinois (Mine B's grid electricity). The high natural gas depletion impacts for Mine D (13%) and Mine C (9.4%) are mostly attributable to the diesel production processes, given the high use of diesel in the mines.

5.1.5. Climate Change Impacts. The life cycle climate change impacts were assessed for each mine using the greenhouse gas emissions in the inventory. Mid-point

characterization modeling was chosen in which the potential for a gas to contribute to climate change, or its Global Warming Potential (GWP) is measured using ‘kg CO₂ equivalent’ as a standard. In this LCA study, the assessment was based on the 100-year time horizon adopted for the Kyoto Protocol gases (IPCC, 2007). The latest GWPs proposed by the Intergovernmental Panel on Climate Change (IPCC), in the Forth Assessment Report (AR4) (IPCC, 2007), were used (Table 5.5). The potential climate change impact in CO₂ equivalent is given by:

$$\text{Climate Change Impact} = \sum_i (\text{GWP}_i \times m_i) \quad (5)$$

where;

GWP_i is the Global Warming Potential for gas i.

m_i is the mass of gas i released per functional unit.

The results of the assessment of potential climate change impacts for the mines are presented in Table 5.6. Mines A1 and A2 have the lowest potential climate change impact of 38 kg CO₂-eq./tonne of coal, followed by Mine B with 54 kg CO₂-eq./tonne, and Mine C with 65 kg CO₂-eq./tonne. The worst performing mine on this impact category is Mine D, which has a potential climate change impact of 92 kg CO₂-eq./tonne. The average potential climate change impact for all the mines is 62 kg CO₂-eq./tonne.

Table 5.5. AR4 - GWPs for 100 year time horizon (IPCC, 2007)

GHG GAS	GWP- AR4
Carbon Dioxide (CO ₂)	1
Methane (CH ₄)	25
Nitrous Oxide (N ₂ O)	298

Table 5.6. Climate change impacts based on AR4 GWPs for 100 year time horizon.

	Climate change impacts (kg CO ₂ eq./tonne coal)				
	Mines A1&A2	Mine B	Mine C	Mine D	Average
CO ₂	17.9	36.4	45.5	70.9	42.7
CH ₄	19.9	17.4	19.8	20.6	19.5
N ₂ O	0.043	0.032	0.037	0.063	0.044
Total	37.9	53.9	65.4	91.5	62.2

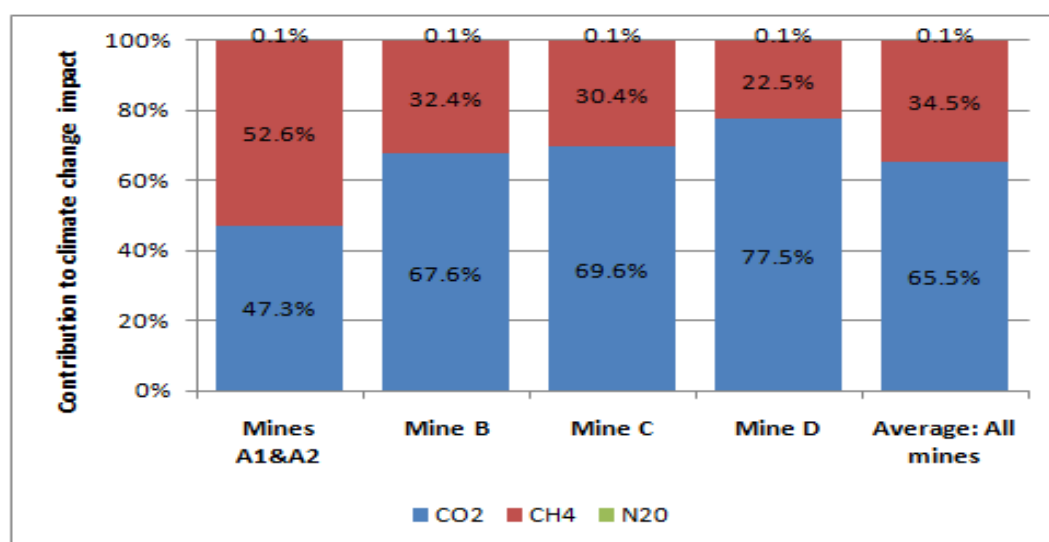

Figure 5.6. Contributions to climate change impacts by different gases

Contributions to climate change impacts by different gases (Figure 5.6) are such that the impact for Mines A1 and A2 is dominated by methane which makes up 53% of the impact indicator. For Mines B, C and D, the CO₂ emissions make up the greater share of the climate change impacts, due largely to the higher energy intensities in the operations. Contributions from N₂O emissions are only marginal for all the mines, with a maximum contribution of 0.1%.

Figure 5.7 shows that coalbed methane emissions directly from the mine, alone, contribute 51% of the overall potential climate change impacts for Mines A1 and A2, with electricity and diesel use contributing almost all the remaining share. The

progressively increasing energy use for Mines B, C and D, is reflected in the dominance of impact indicators for the mines by emissions from diesel use (65% for Mine B, 69% for Mine C and 76% for Mine D). For all the mines, the impacts associated with gasoline, propane and explosives are comparatively negligible, with a maximum combined contribution of about 2.8%.

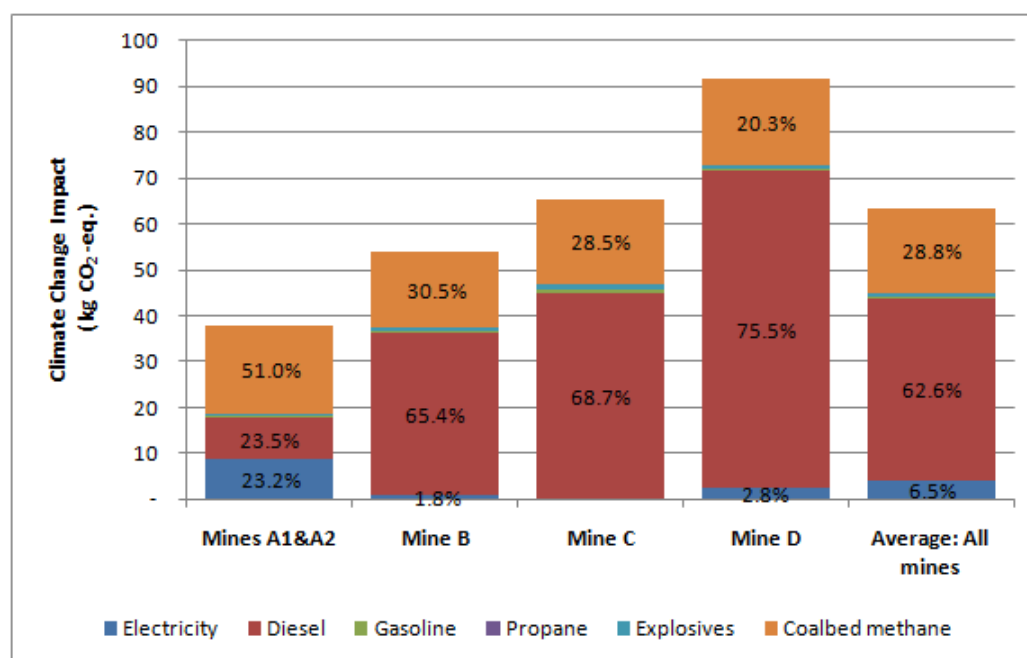

Figure 5.7. Contributions to potential climate change impacts by source

The trend for potential climate change impacts for the mines is fairly comparable to that for energy use (Figure 5.8). The worst performing mine's potential climate impact (Mine D) is just over double that for the best performing Mines A1 and A2, (compare with the energy use impacts, where the assessed impact indicator for Mine D is almost twice that for Mines A1 and A2). In addition to coalbed methane emissions and energy intensity, the mix of energy sources used at a mine has an influence on the potential climate change impacts. Mines A1 and A2 and Mine B have almost equal energy intensities (see Figure 5.8), but, Mines A1 and A2, despite having 15% more coalbed methane emissions, have a potential climate change impact which is 70% of that for Mine

B. This difference in potential impacts can be attributed mostly to the balanced use of diesel and electricity (from a generation resource mix of moderate greenhouse gas emissions) by Mines A1 and A2, while Mine B greatly relies on diesel, whose production, delivery and use results in more CO₂ emissions per unit of energy.

The potential climate change impact for a mine is influenced by among others, coalbed methane emissions, stripping ratios, energy requirements for processing, and the economies of production scale. Given the small variations of coalbed methane emissions between the mines, it can be deduced from Figure 5.9 that the effect of the scale of production on energy use efficiency consequently influences the potential climate change impacts for the mines. The mines with larger scales of production have significantly lower potential climate change impacts.

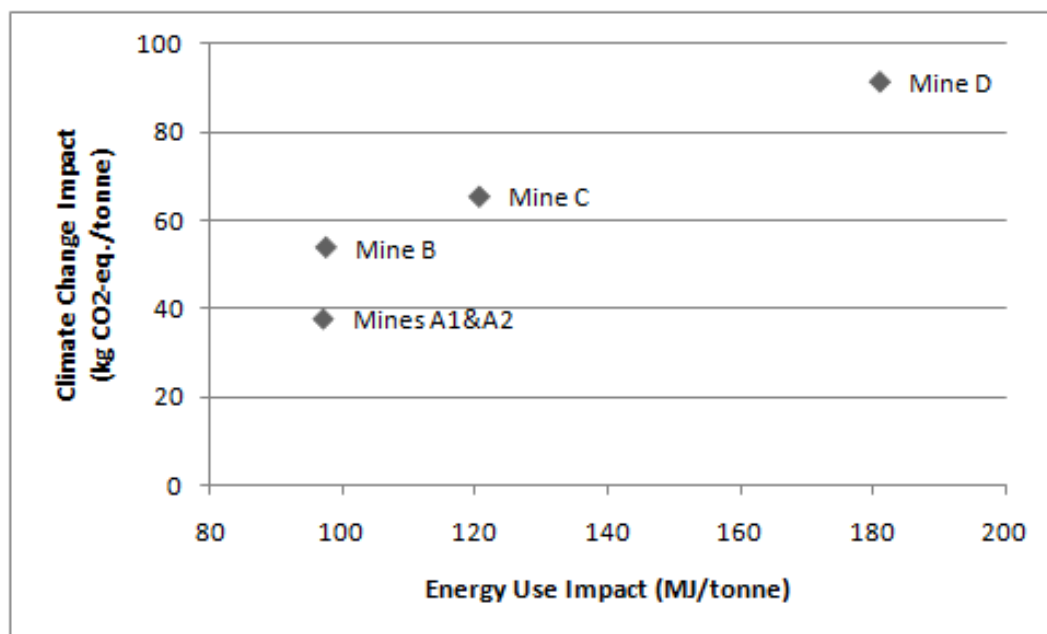

Figure 5.8. Climate change impact versus energy use impact

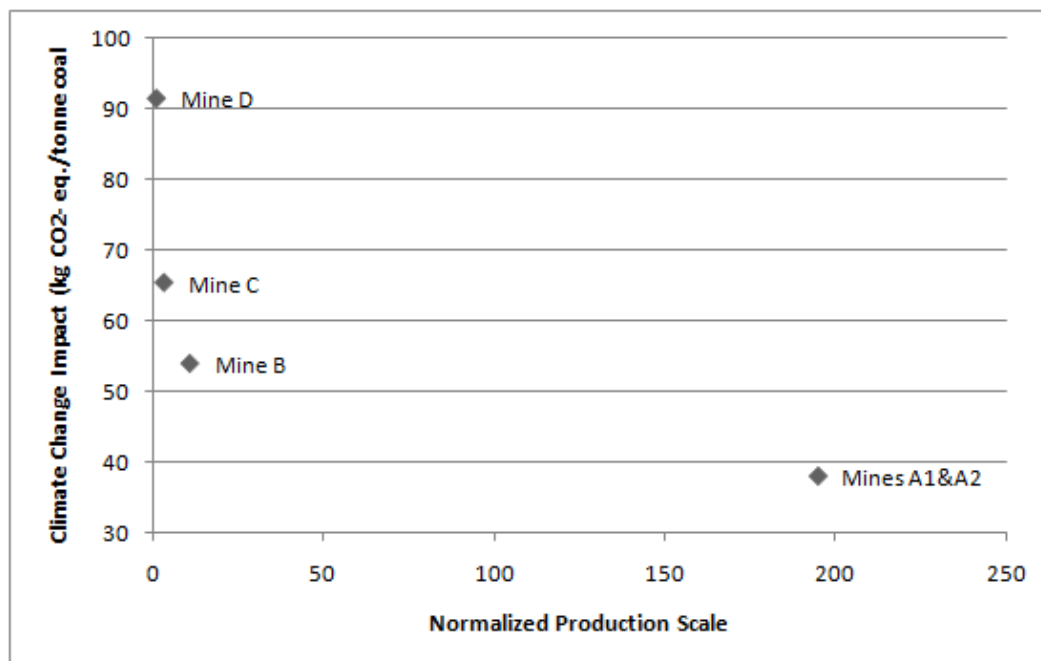

Figure 5.9. Potential climate change impact versus production scale

5.1.6. Performance Ranking. To allow for easy comparison of the performance of the mines, the assessed impact indicators were ranked on a scale of 1 to 4 for each category (1 being the best and 4 the worst). Rankings were done for land use, energy use, abiotic resource depletion and energy use. The comparison of the performances of the mines on water use could not be done because of unavailable data for some mines. The rankings of the mines' performances are presented in Table 5.7

Table 5.7. Rankings of the mines' performances for each impact category

	Ranking of indicators*			
	Mines A1&A2	Mine B	Mine C	Mine D
Land use	2	1	4	3
Energy use	1	2	3	4
Abiotic resource depletion	1	2	3	4
Climate change	1	2	3	4

* Mines are ranked from 1 to 4 with the best performance (lowest impact) given a rank of 1

5.2. SENSITIVITY ANALYSIS

Sensitivity analysis was conducted to identify significant unit processes and assumptions, and their effects on the LCA results. This analysis was carried out for energy use, resource depletion and climate change impacts. Sensitivity analysis is important for these because of the many unit processes which contribute towards the potential impacts, and the various assumptions that could affect the overall results. On the other hand, sensitivity analysis could not be carried out for water use and land use because:

- Only limited data on water use impacts was available for this research work, and the available data was presented as aggregate figures for all processes in the mines.
- Some of the parameters used in the characterization of land use impacts do not lend themselves to variation. For instance, the coal resource area that can potentially be affected by coal extraction cannot be changed without changing the coal reserves, and changing the area disturbed by development of facilities would only be reasonable if it is accompanied by a change in the scale of production.

5.2.1. Energy Use Impacts. Three different scenarios were modeled and their effects on the energy use impacts evaluated. They included, assuming all the mines used the same electricity generation resource mix (the 2005 US generation resource mix), and varying electricity and diesel, individually. In addition to evaluating implications of LCA data variance from the actual, the sensitivity analysis scenarios were also intended to inform improvement scenarios corresponding to reductions of inputs by the given proportions.

The results of changing the electricity generation resource mixes for the mines to the average US generation resource mix, are presented in Figure 5.10. The results indicate that the potential energy use impact is influenced to some extent by the electricity generation resource mix. The potential energy use impact for Mine C, which uses electricity from diesel, is more sensitive to the change in generation resource mix,

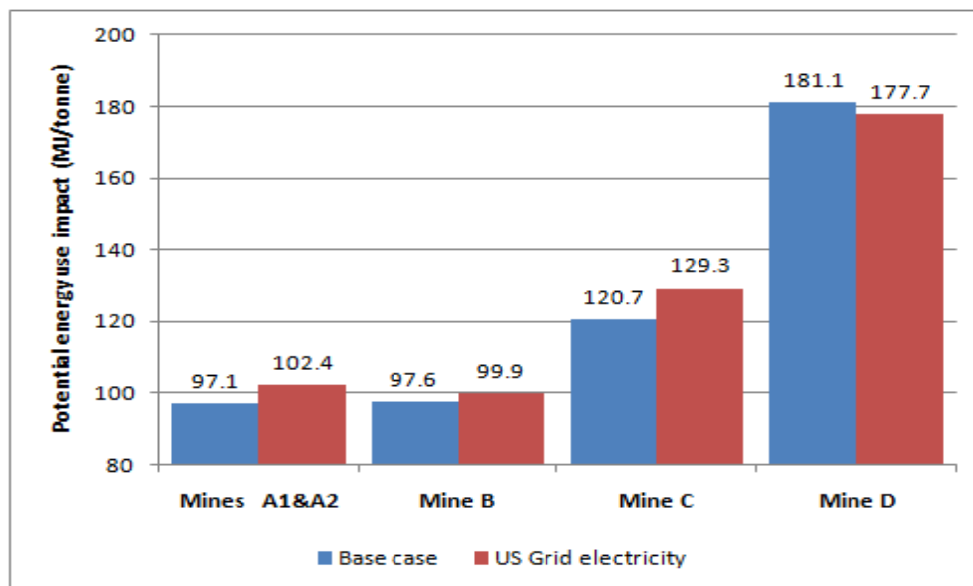

Figure 5.10. The effects of changing the electricity generation resource mix on potential energy use impacts

responding with a 7% increase. Mines A1 and A2, which use more electricity per tonne of coal, experience a 6% increase in potential impact. Impacts of Mines B and D are the least sensitive to this variation in electricity generation resource mix, with Mine B's potential impact increasing by 2% and that for Mine D declining by 2%. For each mine, the effects of the variation on energy use impact is indicative of the proportion of electrical energy to the total energy used in a mine, as well as the extent of variation of the mine's electricity generation resource mix from the average for the US.

The comparisons of the sensitivity of potential energy use impacts to variations in the amount of electricity and diesel used (Figure 5.11) show that the impact indicator for Mines A1 and A2 is four times more sensitive to changes in electricity than diesel (it experiences a change of about 0.8% for a percentage point variation in electricity consumption, but only a 0.2% change for the variation in diesel consumption). This response is indicative of the greater use of electricity in the mine complex. On the other hand, the mines that predominantly use diesel (Mines B, C and D) show a change of about 0.8% in their impacts, for a unit percentage variation in diesel use, but only a maximum change of 0.1% in the impacts, for a percentage point variation in electricity use.

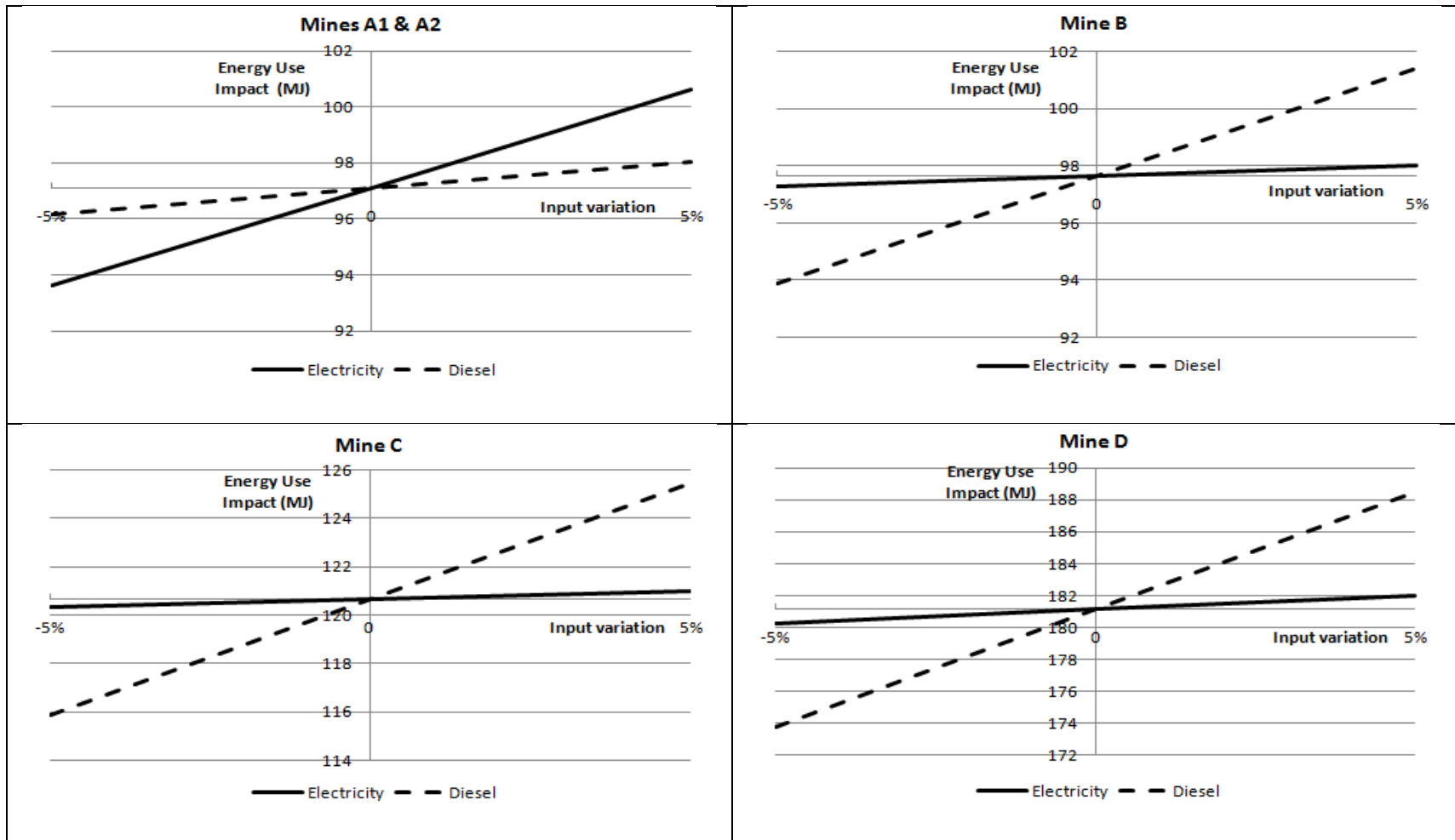

Figure 5.11. Sensitivity of energy use impacts to variations in electricity and diesel use

5.2.2. Resource Depletion Impacts. The same scenarios used for potential energy use impacts were applied for the abiotic resource depletion impacts. The results of the variation of the electricity generation resource mix as presented in Figure 5.12 show that the abiotic resource depletion impact for Mines A1 and A2 is more sensitive to the variation when compared to the impacts for the other mines. Mines A1 and A2 experience a 1% reduction in the impact, and the impacts for the other mines show smaller increments of 0.5% for Mine B, and 0.2% for Mine C. The impact indicator for Mine D hardly responds under this scenario because of the relatively insignificant contribution of electricity to the impact indicator for the mine, compared to the overwhelming contribution from diesel use.

The spidergrams in Figure 5.13 show the sensitivity analysis results for variations of electricity and diesel consumption. The resource depletion impact for Mines A1 and A2 responds more to the variation in electricity consumption, giving a 0.1% change for a percentage point variation in electricity consumption, compared with a 0.04% change for similar variation in diesel consumption.

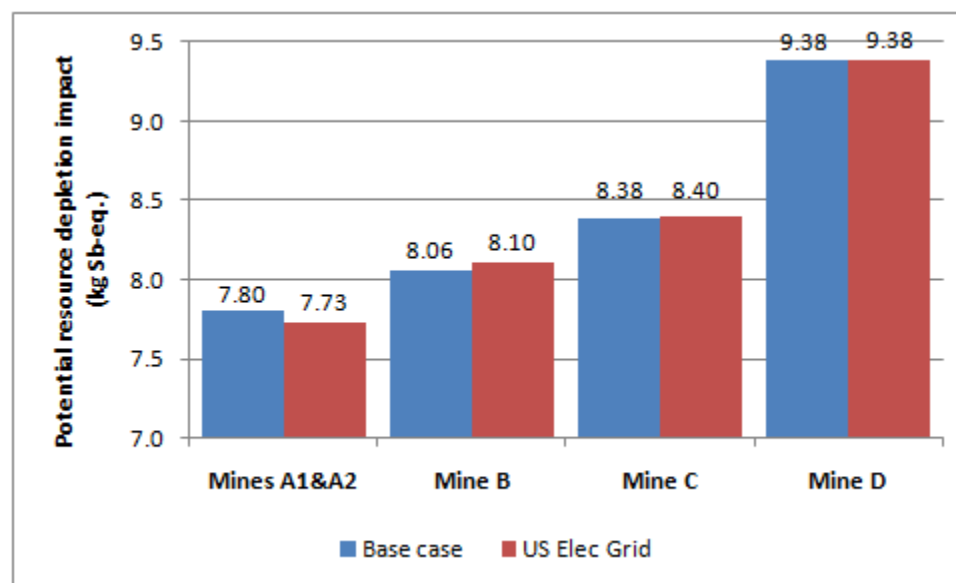

Figure 5.12. The effects of change in electricity generation resource mix on potential resource depletion impacts

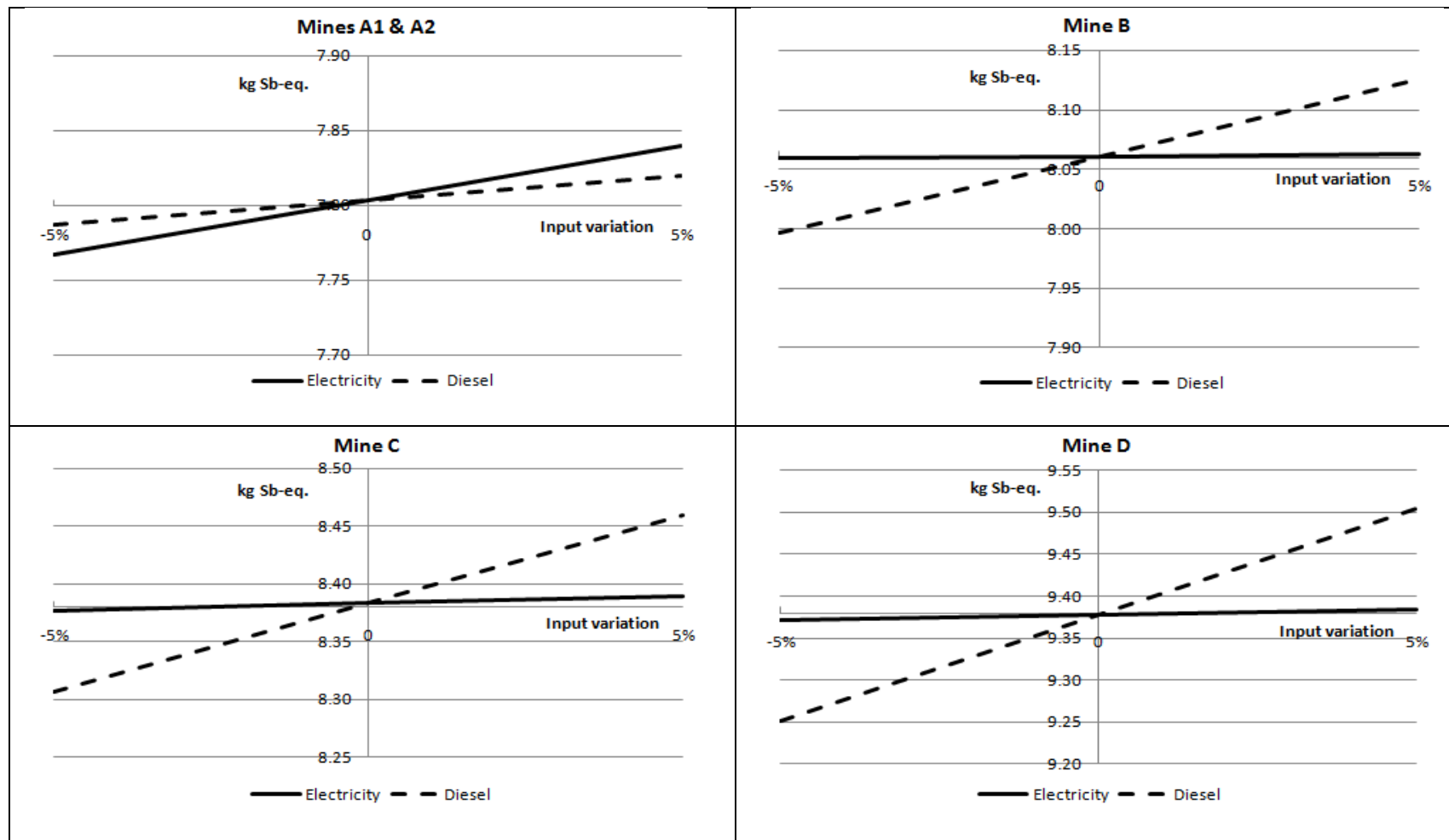

Figure 5.13. Sensitivity of resource depletion impacts to variations in electricity and diesel use

The abiotic resource depletion impacts for Mines B, C, and D respond at least ten times more to diesel consumption variations than to electricity consumption variations (0.2% change in impact for a unit percentage variation in diesel consumption, compared with a maximum change of about 0.02% for a similar variation in electricity consumption).

5.2.3. Climate Change Impacts. In addition to the scenarios of electricity generation resource mix, variation in electricity use and variation in diesel use, coalbed methane emissions were also varied in the sensitivity analysis, because of their significance to climate change impact. It was assumed that the proportion of methane cut from the emissions was converted to the less potent CO₂ either by flaring or during use for energy generation. The conversion to CO₂ is via the reaction in Equation (6).



From Equation (6), 16 g-of CH₄ should produce 44 g-of CO₂. Applying the AR4 -GWPs, CH₄ of 400 g CO₂-eq. potential impact should be converted to CO₂ of potential climate change impact equal to 44 g CO₂-eq. This should result in 89% reduction of potential climate change impact.

The variation in the electricity generation resource mix has a marked effect on the potential climate change impact for Mines A1 and A2, resulting in a 3% increase in the impact (Figure 5.14). The scenario leads to a 0.5% increase in the climate change impact for Mine B, and reductions in impacts equal to almost 2% for Mine C and 1% for Mine D.

The results of the sensitivity analysis in Figure 5.15 show that potential climate change impact for Mines A1 and A2 is almost twice as sensitive to coalbed methane variations than it is to electricity or diesel use. Variations in electricity and diesel use cause equal changes in the potential impact. On the other hand, the climate change impacts for Mines B, C and D are more sensitive to diesel use variations because of the dominance of the impacts by emissions from diesel use. For these mines, the variations in coalbed methane emissions cause a more pronounced effect on the impacts than similar proportional variations in electricity consumption.

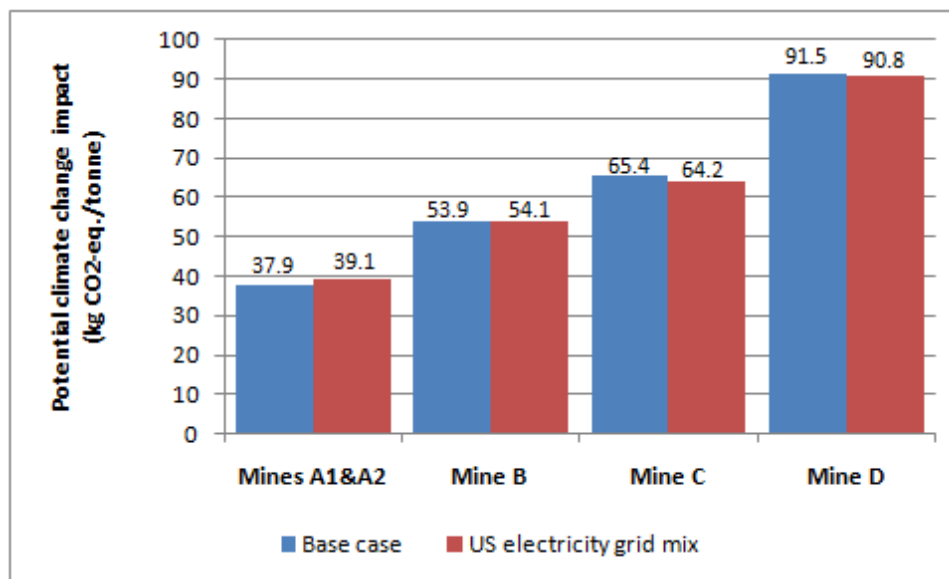

Figure 5.14. The effects of change in electricity generation resource mix on potential climate change impacts

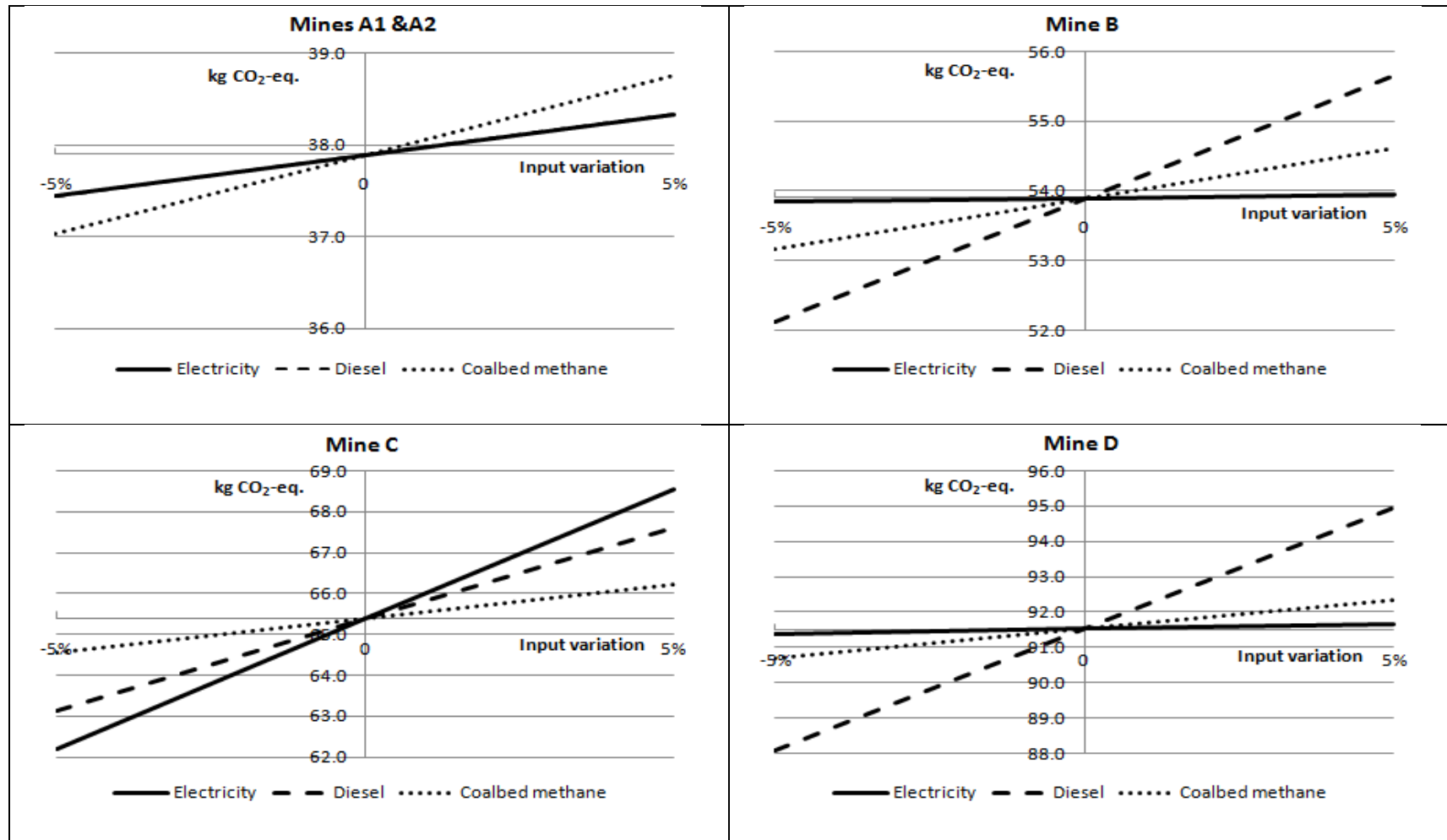

Figure 5.15. Sensitivity of climate change impacts to variations in electricity, diesel and coalbed methane emissions

5.3. DATA QUALITY AND UNCERTAINTY

Data quality is important for the accuracy and, therefore, the significance of the LCA results, as well as the validity of conclusions drawn from the LCA results. Uncertainties in LCA results may be due to factors such as, completeness of input data, accuracy and relevance of input data, and assumptions used in the LCA study. In addition, some uncertainties are inherent in life cycle impact assessment characterization models. Potentially significant sources of uncertainty in the results of this LCA were identified and addressed qualitatively.

5.3.1. Completeness of Data. Completeness of data is critical to the accuracy of an LCA, however it is not always possible to collect all the necessary data for an LCA. As is the case in most LCA studies, acquisition of data was a major challenge in this LCA study. Some unit processes had to be eliminated from the LCA product system model because of a lack of data. However, precautions had to be taken to ensure that the processes excluded were those whose contributions to the impact categories of interest in this LCA study, were only marginal. The choice of unit processes to include in the system boundaries was based on the use of appropriate scoping methods. As required by the ISO standards, quantitative scoping methods, (the RMEE method), were used to select significant unit processes. The use of quantitative methods should limit the level of uncertainty due to the exclusion of some unit processes.

5.3.2. Relevance of Data. Where mine specific data was not available, temporal, geographical, and technological relevance were considered to select appropriate data for the operations (e.g. use of relevant coal basin data in place of mine specific data, and use of State electricity generation resource mix where source of power was not specified). This should reduce the uncertainty from applying other data (modeled or empirical).

5.3.3. Water Use Data. Data necessary for the assessment of water use impacts was only available for two of the case study mines, and this prevented comparisons of performance of the mines on this impact category. The available data on water

consumption was from records of the mines' operations over many years, and this makes the validity of the data high.

5.3.4. Land Use Data. While data on coal production, land disturbance, coal resource area and reserves was available for all the mines, what was missing was the timeline on land disturbance and land reclamation for mines, B, C and D. Assumptions on the distribution of land area disturbances and reclamation areas over the years could be the main source of the uncertainty in the assessed land use impact indicators.

5.3.5. Energy Consumption Data. A lack of measured data on energy consumption for some mines is one of the main sources of data uncertainty that could affect the LCA results. The lack of appropriate data on consumption of fuels, electricity and explosives necessitated that some data be modeled, based on the available parameters for the mines. Most of the data was obtained from mining permit application documents. In order to get reasonable estimates on energy consumption, only the mines which had been in operation for some years were selected for this study. Therefore, some historical data was available for the mines chosen. Specifications from Original Equipment Manufacturers and reputable sources of mine equipment estimates information (InfoMine), were used in the estimation of energy consumption. All this care should minimize the uncertainty introduced by modeling.

5.3.6. Methane Emissions Data. One potential source of uncertainty in the results of this LCA study is the data on coalbed methane emissions, especially given the influence of methane emissions on climate change impacts assessed for the case study mines. In cases where mine specific coalbed methane emissions data was not available, data for the coal basin within which the mine is located was used. However, emissions rates are not necessarily the same at different locations in the same basin, as they are influenced by various factors such as, seam thickness and the closeness of seam to the surface. However, since the emission values for coal basins are averages based on measurements carried out at mines within the coal basins, in the absence of mine specific data, these values are the best estimates.

Measurements of coalbed methane emissions do not take into account emissions that may continue in the post closure phase due to remnants of coal left on the ground and in the overburden spoils. Due to the high recovery rates associated with surface mining

methods, the coal left behind should be relatively small, and therefore the methane emissions should be relatively small.

5.3.7. Uncertainties Inherent in LCIA. Uncertainties that are inherent in the characterization models used for the assessment of impacts were kept to a minimum through selection of appropriate LCIA steps and characterization factors. The study avoided, end-point modeling, instead, preferring midpoint modeling for which there is higher confidence in the characterization factors. Where characterization factors were used, the latest, derived from improved characterization models were used. Some optional LCIA steps usually associated with ambiguities were excluded to maintain the integrity of the LCIA results.

Despite the shortfalls identified in the data, in general, this study has taken into account the major sources of potential impacts. Subject to data availability, attempts have been made to use data that is consistent and relevant in terms of age, geographical and technological basis. Deviations of LCA data from actual mine situation are believed to be not so wide as to invalidate the results of this study. So, the LCIA results of this study should be a fair reflection of the environmental performances for the case study mines.

5.4. IMPROVEMENT

The recommendations for improvement are not aimed at addressing all the possible sources of impacts, but rather they focus on the identified major contributors to the evaluated potential impacts. The improvement options suggested here are in the context of what can reasonably be done within a mine, and so, all processes for which the mines do not have control over, are left out.

5.4.1. Efficient Use of Land. There is not much change that could be done to the land area impacted by mining, without reducing reserves (in the case of trying to cut down the coal resource area impacted), or limiting the scale of operation (in the case of trying to reduce the area occupied by facilities). Generally, the reclamation of land occupied by most facilities can only be done following cessation of coal extraction activities. Facilities serving large scale operations tend to use land more efficiently, as a smaller foot print is disturbed per tonne produced. Also, high production rates shorten the

duration of land occupation, leading to minimized land use impacts. So, where reserves permit, large scale operations should be preferred over small scale for lower land use impacts.

5.4.2. Energy Use Efficiency. Electricity and diesel have been identified as the main energy sources used in coal mining, which therefore contribute significantly to energy use impacts, fossil fuel resource depletion, and climate change impacts. Efficient use of energy can address all the three impact categories. From the assessment of these impacts, it has been established that the scale of operation is one of the major factors that influence these impacts. Small scale operations tend to be inefficient in the use of energy, leading to high resource depletion impacts for fossil fuels and high greenhouse gas emissions associated with climate change impacts. Therefore, where conditions permit, preference should be given to large scale operations.

On their own, large production units represent efficiency. However, for such a piece of equipment, what may appear to be minor deviations from optimal performance can add up to substantial losses in production and energy wastage. A study of dragline operator productivity by Lumley (2005) noted variability of up to 35% about the mean. Such variability presents opportunities for reduction of energy use related impacts by simple measures such as improvement of operators' performance. Improving operator competence to ensure optimal use of available equipment can be achieved with relative ease, compared to technological innovations which usually come at great a costs. So, in addition to opting for large scale operations, or even in cases where it is not feasible to implement large scale production, there should be measures to improve efficient energy use in the mining processes.

5.4.3. Coalbed Methane. Coalbed methane accounts for a significant portion (20 to 51%) of the potential climate change impacts. Where conditions allow, coalbed methane should be tapped ahead of coal extraction through degasification systems and used for energy generation. The use of methane reduces the need for other fossil fuels (reducing the abiotic resource depletion impact), while at the same time reducing contributions to climate change impacts by converting the gas into the less potent CO₂. Otherwise if it not feasible to collect coalbed methane for use, burning by flaring to convert it to CO₂ may be the best alternative.

6. CONCLUSIONS AND RECOMMENDATIONS FOR FUTURE WORK

6.1. CONCLUSIONS

Coal is an important energy source which contributes immensely to many industrial processes, including, electricity generation. Many products are linked to coal directly or indirectly. However, a review of the literature reveals that little attention has been given to life cycle assessment of coal mining. Available literature shows limited details on the coal mining stage in LCAs of electricity generation. The few LCA studies that focus on coal mining, either analyze the environmental flows only to the point of inventory analysis phase, or ignore the impacts that are important and specific to coal mining. The former is because the current LCA framework does not make provisions for these impacts to be recognized as LCA impact categories. The limited LCA work focusing on coal mining products has led to LCI data gaps which undermine the accuracy of the results for LCA studies of electricity and many other products which use coal-fired electricity.

This research work was aimed at providing an understanding of environmental impacts of surface coal mining from an LCA perspective, as well as to contribute towards filling the LCI data gap on coal mining products. The study was intended to provide unique baseline information which could be used by the coal mining industry and public policy makers in devising environmental management strategies and policies to curb the environmental impacts associated with coal.

The goal of this research work was to use the general principles of the ISO 14040-49 series of standards, and to adapt them where appropriate, in a cradle-to-gate life cycle assessment for the production of bituminous coal from surface mining in the US. In this study, the functional unit was defined as '*one tonne of processed coal at the mine gate*'. The potential life cycle impacts were assessed for water use, land use, energy use, abiotic resource depletion and climate change. Five case study mines that use strip mining, with annual production rates ranging from 62,000 tons to 8.5 million tons, were used in this work. The mines include Black Mesa (Mine A1) and Kayenta (Mine A2), both in Arizona; Wildcat Hills Mine Cottage Grove Pit (Mine B), located in Illinois; and

Cottonwood Creek (Mine C) and Hume (Mine D), both located in Missouri. The mines' performances were compared, based on impact indicators, and the parameters influencing performance were identified for each impact category. Sensitivity analysis was conducted to identify the dominant sources of impacts, and recommendations were made on improvements to address the dominant sources of impacts. The following conclusions are drawn from this work:

- The life cycle water use impact for the production of coal from surface mining has been determined to be 178 liters per tonne of coal. However, the assessment for this impact category was limited by data unavailability for some of the case study mines.
- The potential land use impacts, assessed from the perspective of land occupation, range from 3m²-year/tonne, for the best performing mine, to 10 m²-year/tonne, for the worst performing mine, with an average of 6.7 m²-year per tonne for all the mines. Land use impacts are dominated by land affected by coal extraction activities. The influence of climatic conditions of a region on the recovery of vegetation, following land reclamation, is also important for the land use impacts.
- The potential energy use impacts per tonne of coal range from 97 MJ for Mines A1 and A2; 98 MJ for Mine B; 121 MJ for Mine C, and 181 MJ for Mine D. The average for all the case study mines is 124 MJ. Electricity use contributes the largest share of the energy use impact indicator assessed for Mines A1 and A2, while the impacts for Mines B, C, and D are dominated by diesel use.
- The potential abiotic resource depletion impacts, assessed with respect to the depletion of coal, natural gas and petroleum, are 7.8 kg Sb-eq./tonne for Mines A1 and A2, 8.1 Sb-eq./tonne for Mine B, 8.4 Sb-eq./tonne for Mine C and 9.4 kg Sb-eq./tonne for Mine D. The average resource depletion indicator for the mines is 8.4 kg Sb-eq/tonne of coal produced. The heavy use electricity in Mines A1 and A2 leads to a high proportion of total resource depletion impact attributed to coal depletion, and only a small contribution from petroleum depletion. Mines B, C and D have relatively higher depletion of petroleum resource compared to Mines A1 and A2.

- Mines A1 and A2, B, C and D have potential climate change impacts of 38, 54, 65 and 92 kg CO₂-eq./tonne of coal, respectively. The average potential impact for all the mines is 62 kg CO₂-eq./tonne of coal produced. Coalbed methane is more important for the climate change impacts assessed for Mines A1 and A2 because of the relatively small use of energy at the mines. However, climate change impacts for Mines B, C and D are dominated by CO₂ emissions from diesel use.
- Mine B has the best performance on potential land use impacts, and it is followed by Mines A1 and A2, Mine D, and Mine C in that order. For energy use, abiotic resource depletion and climate change impacts, Mines A1 and A2 have the lowest impact indicators, followed by Mines B, C, and D in that order.
- The economies of scale have a marked influence on the land use impacts, (particularly, the efficiency of the use of land occupied by mine facilities), energy use impacts, abiotic resource depletion impacts and climate change impacts.
- Factors arising out of geological conditions, such as stripping ratios, influence the land use impacts, particularly the land disturbances in the coal resource areas. Stripping ratios determine the energy requirements for overburden removal and reclamation efforts. Geological conditions also determine the methane emission rates from strata (which contributes to climate change impacts), and the quality of coal in the ground (which has a bearing on the beneficiation energy necessary to meet the specifications desired by customers).
- The recommended improvements include, timely reclamation behind coal extraction to minimize land occupation impacts, as well as adoption of large scale of production, where appropriate, for efficient use of land occupied by mine facilities. Measures to improve energy efficiency in the mines are important for curbing potential energy use, abiotic resource depletion and climate change impacts. The contribution of coalbed methane to climate change impacts can be lowered by tapping it for use as an energy source, or it can be flared.

6.2. RECOMMENDATIONS FOR FUTURE WORK

The following recommendations are given in order to contribute towards LCA improvement in general, as well as to improve the work on the LCA of coal mining:

- There is need to develop characterization models that can be standardized for impacts that are more relevant to coal mining. Some environmental impacts that are important and peculiar to coal mining have not been standardized as impact categories in LCA. As a result, either LCA practitioners do not assess those impacts in their studies, for fear of nonconformity with the LCA framework and standards, or others use various, individually developed characterizations for the impacts, leading to ambiguity in the LCA results. It is likely that the coal mining industry would be less willing to accept any environmental systems analysis tool that leaves out impacts regarded as critical in the industry.
- Further research is required to evaluate other life cycle impact categories to address more resource inputs and emissions to air, water and ground. The incorporation of other impact categories would provide a complete evaluation of the potential environmental impacts of coal mining, and could further close the LCI data gap for coal mining products.
- It is essential to have impacts assessed for individual processes in coal mining to facilitate pinpointing of critical processes. This study has assessed impacts for coal mining as though it is one process, and this assessment does not offer opportunities to scrutinize the individual processes in coal mining.
- There is need for coverage of more mines. Coverage should be across different scales of production and across diverse coal basins in the US, in order to improve confidence in the accuracy and representativeness of the LCA results to the US as a geographical scope.
- There is need for site measured data. This will help validate some of the data which has been obtained from literature and from modeling.

APPENDIX A.
INVENTORY ANALYSIS CALCULATIONS

List of major equipment for the Black Mesa and Kayenta complex (Mines A1 & A2)

VEHICLE/EQUIPMENT	FUEL/ ENERGY TYPE	AVERAGE ENGINE POWER (HP)	NO. OF UNITS
Processing Equipment			
• Coal processing plants	Electric		4
Electric mining equipment			
• Draglines	Electric		6
• Shovel	Electric.		1
Diesel mining equipment			
• Tractor/backhoe/trencher	Diesel	100	36
• Crane/large forklift	Diesel	400	23
• Welder/compressor	Diesel	300	24
• Dozer/loader	Diesel	850	54
• 150 to 250ton coal haul trucks	Diesel	1,500	25
• Semi-trailer/trailer	Diesel	350	22
• Drill	Diesel	300	11
• Grader/scrapper	Diesel	600	19
Vehicles			
• Pick-up truck	Diesel	200	2
• 2 ton trucks	Diesel	250	32
• 2 to 5 ton trucks	Diesel	300	22
• 5 to 15 ton trucks	Diesel	400	27
• Pickup/crewcab/sub-urban	Gasoline	200	70

Fuel and electricity consumption for equipment: Black Beauty Coal Company - Wildcat Hills Cottage Grove Pit (Mine B)

Equipment	No. of Units	Model/ Capacity Listed	Model Assumed	Gross Power (kW/hp)	Load Factor	Fuel	Fuel Consumption Rate (L/hour)		Annual Fuel Consumption (L)		
							Min.	Max.	Min.	Max.	Average
Hydraulic Excavator	1	25yd3	CAT5230B	1096/1470	40-50%	Diesel	208	227	698,880	762,720	730,800
Front-end Loader	1	CAT 988	CAT 988H	395/530	65-80%	Diesel	65.1	70.6	218,736	237,216	227,976
Haul Truck	3	190 ton	CAT 789C	1418/1900	40-50%	Diesel	141.2	176.5	1,423,296	1,779,120	1,601,208
Haul Truck	3	100 ton	CAT 777D	700/938	40-50%	Diesel	75	93.8	756,000	945,504	850,752
Dozer	3	D10	CAT D10T	433/580	65-80%	Diesel	79.5	97.7	801,360	984,816	893,088
Dozer	3	D9	CAT D9N	403/540	65-80%	Diesel	56.4	69.3	568,512	698,544	633,528
Scraper	2	CAT637	CAT 637G	345/462	65-80%	Diesel	113.5	121	762,720	813,120	787,920
Grader	1	CAT16G	CAT 16M	220/297	65-80%	Diesel	32	40	107,520	134,400	120,960
Overburden drill	1		Drilltech D75K	500/675	65-80%	Diesel	74.1	85.2	248,976	286,272	267,624
Bulk powder truck	1			156/210	50%	Diesel		30		50,400	50,400
Maintenance truck	1			245/330	50%	Diesel		42		70,560	70,560
Lube truck	1			245/330	50%	Diesel		42		70,560	70,560
Fuel truck	1			245/330	50%	Diesel		42		70,560	70,560
Water truck	1			245/330	50%	Diesel		42		70,560	70,560
Mobile crane	1		Liebherr LTF1035	91/122	50%	Diesel		13.2		22,176	22,176
Fork lift	1		CAT TH210	60/80	40-50%	Diesel	11.8	13.5	22,656	45,360	34,008
Generator and light plant	1			7.8/10.5		Diesel		1.71		2,052	2,052
Generator and pump	1			74/100		Diesel		12.4		9,300	9,300
Total Diesel Consumption											6,514,032
Pickup/crew cab trucks	15					Gasoline				105,120	105,120
Total Gasoline Consumption											105,120
Processing plant (18%) ²		1400 ton/hour		1036/1400	100%	Electric				980,138kWh	980,138kWh
Total Electricity Consumption											980,138kWh

Diesel consumption based on two 8hour shifts per day for 360 days per year, with operational efficiency of 85%

Pickup/crew cab trucks¹ - Gasoline consumption based on 1 gallon per 19.7 miles for a maximum of 50 miles per 8 hour shift.

(18%)² - Cottage Grove Pit's share of Willow Lake Preparation Plant 3.7 million ton annual production at 1400 tons/hour capacity plant

Fuel and electricity consumption for equipment: Continental Coal Company – Cottonwood Creek Mine (Mine C)

Equipment	No. of Units	Model/ Capacity Listed	Model Assumed	Gross Power (kW/hp)	Load Factor	Fuel	Fuel Consumption Rate (L/hour)		Annual Fuel Consumption (L)		
							Min.	Max.	Min.	Max.	Average
Excavator	2	CAT 345	CAT 345C L-VG	257/345	40-50%	Diesel	50.5	55.5	288,456	317,016	302,736
Dozer	2	CAT D10	CAT D10T	430/580	65-80%	Diesel	79.5	97.7	454,104	558,062	506,083
Front end loader	2	CAT 966D	CAT 966D	195/262	65-80%	Diesel	27	32	154,224	182,784	168,504
Motor Grader	1	CAT 140G	CAT 140G	82/110	65-80%	Diesel	19	25	54,264	71,400	62,832
End dump truck	4	CAT 773	CAT 773F	552/740	40-50%	Diesel	56.6	70.8	646,598	808,819	727,709
Blasthole Drill	2	Reedril SK 40	Reedril SK 40	444/600	65-80%	Diesel	70	80	399,840	456,960	428,400
Bulk powder truck	1			156/210	50%	Diesel		30		42,840	42,840
Maintenance truck	1			245/330	50%	Diesel		42		59,976	59,976
Lube truck	1			245/330	50%	Diesel		42		59,976	59,976
Fuel truck	1			245/330	50%	Diesel		42		59,976	59,976
Water truck	1			245/330	50%	Diesel		42		59,976	59,976
IC Diesel Generator		1.65MMBtu/hour	C15 ACERT TA	483 kW	90%	Diesel		48		188,698	188,698
Total Diesel Consumption											2,667,706
Pickup/crew cab trucks ¹	6									42,048	42,048
Total Gasoline Consumption											42,048
Roll Crusher ²	1	Hycaloder		186/250	100%	Electric.				517,650 kWh	517,650 kWh
Total Electricity Consumption											517,650 kWh

Diesel consumption based on two 8 hour shifts per day for 360 days per year, with operational efficiency of 85%

Pickup/crew cab trucks¹ - Gasoline consumption based on 1 gallon per 19.7 miles for a maximum of 50 miles per 8 hour shift.

Roll Crusher² - Annual energy consumption based on 300 ton/hour capacity crusher producing a total of 200,000 tons

Fuel and electricity consumption for equipment: Continental Coal Company – Hume Mine (Mine D)

Equipment	No. of Units	Model/ Capacity Listed	Model Assumed	Gross Power (kW/hp)	Load Factor	Fuel	Fuel Consumption Rate (L/hour)		Annual Fuel Consumption (L)		
							Min.	Max.	Min.	Max.	Average
Excavator	2	CAT 345	CAT 345C L-VG	257/345	40-50%	Diesel	50.5	55.5	144,228	158,508	151,368
Dozer	1	CAT D9N	CAT D9N	275/370	65-80%	Diesel	56.4	69.3	80,539	98,960	89,750
Dozer	2	CAT D8R	CAT D8R	227/305	65-80%	Diesel	41.5	51	118,524	145,656	132,090
Dozer	1	CAT D4H	CAT D4H	75/105	65-80%	Diesel	13	15	18,564	21,420	19,992
Front end loader	1	CAT 966	CAT 966G	195/262	65-80%	Diesel	27	32	38,556	45,696	42,126
Front end loader	1	CAT 926	CAT 926E	82/110	65-80%	Diesel	15	19	21,420	27,132	24,276
End dump truck	3	CAT 777	CAT 777D	758/1016	40-50%	Diesel	75	93.8	321,300	401,839	361,570
Drill	2	Reedril SK 40	Reedril SK 40	444/600	65-80%	Diesel	70	80	199,920	228,480	214,200
Bulk powder truck	1			156/210	50%	Diesel		30		21,420	21,420
Maintenance truck	1			245/330	50%	Diesel		42		29,988	29,988
Lube truck	1			245/330	50%	Diesel		42		29,988	29,988
Fuel truck	1			245/330	50%	Diesel		42		29,988	29,988
Water truck	1			245/330	50%	Diesel		42		29,988	29,988
Total Diesel Consumption											1,176,743
Pickup/crewcab trucks ¹	4					Gasoline				9,272	9,272
Total Gasoline Consumption											9,272
Portable Roll Crusher ²	1	Jim Pyle		74/100	100%	Electric				132,090 kWh	132,090 kWh
Total Electricity Consumption											132,090 kWh

Diesel consumption based on one 8 hour shift per day for 310 days per year, with operational efficiency of 85%

Pickup/crew cab trucks¹ - Gasoline consumption based on 1 gallon per 19.7 miles for a maximum of 50 miles per 8 hour shift.

Portable Roll Crusher² - Annual energy consumption based on 120 ton/hour capacity crusher producing a total of 62,000 tons

Explosives Requirements: Continental Coal Company – Cottonwood Creek mine

Type of overburden material blasted: shale.

Thickness of coal seam : 26 inches.

Hole diameter : 6¾ inches

Depth of hole : 48 ft

Burden X Spacing : 20 ft x 20 ft

Explosives used : Bulk ANFO and 0.75 lb PETN primer

Explosives Density : 0.90 g/cm³ (56.2 lb/ft³)

Energy content of ANFO : 803.64 kcalories/kg ANFO as per Aimone (1992)
803.64 kcalories/kg ANFO = 3.36x10³ MJ/tonne ANFO

Explosives weight per hole : 501 lb ANFO (14 lb/ft column)

Powder factor : 0.026 lb/ft³

Volume of coal exposed per blast hole = Area x Seam thickness
= 20 ft x 20 ft x (26/12)ft = 867 ft³

Amount of coal exposed per hole = 867 ft³ x 84 lb/ft³ = 72,828 lb = 36.4 tons
= 33.0 tonnes

Explosives per tonne of coal = 510 lb ANFO x (0.4536 kg/lb)/33 tonnes
= 6.914 kg ANFO/tonne coal

Explosives Requirements: Continental Coal Hume Mine

Type of overburden material blasted: shale, sandstone and limestone.

Thickness of coal seam	: 26 inches.
Hole diameter	: 5½ inch to 6¾ inch
Depth of hole	: 50 ft
Stemming	: 10 ft
Length of charge	: 40 ft
Burden X Spacing	: 18 ft x 18 ft
Explosives used	: Bulk ANFO and 0.75 lb PETN primer
Explosives Density	: 0.90 g/cm ³ (56.2 lb/ft ³)
Energy content of ANFO	: 803.64 kcalories/kg ANFO 803.64 kcalories/kg ANFO = 3.36x10 ³ MJ/tonne ANFO
Explosives weight per hole	: 368 lb ANFO (9.2 lb/ft column of charge)
Powder factor	: 0.023 lb ANFO/ft ³
Volume of coal exposed per blast hole	= Area per hole X Seam thickness = 18ft x 18ft' x (35/12)ft = 945 ft ³
Amount of coal exposed per hole	= 945 ft ³ x 84 lb/ft ³ = 79380 lb = 39.7 tons = 36.0 tonnes.
Explosives per tonne of coal	= 368 lb ANFO x (0.4536 kg/lb)/36 tonnes = 4.656 kg ANFO/tonne coal

Explosives Requirements: Peabody Western Coal Company, Black Mesa and Kayenta Mines

Type of overburden material blasted: unspecified

Overburden and interburden :37.9 ft

Thickness of coal seam : 78 inches

Hole diameter : 6¾ inches (Assumed)

Depth of hole : 38 ft (Assumed)

Powder factor : 0.026 lb/ft³ (Assumed)

Burden X Spacing : 20.7 ft x 20.7 ft

Explosives used : Bulk ANFO (Assumed)

Explosives weight per hole : 424 lb ANFO (14 lb/ft column)

Volume of coal exposed per blast hole = Area x Seam thickness
 = 20.7ft x 20.7ft x (78/12)ft = 2785 ft³

Amount of coal exposed per hole = 2785 ft³ x 84 lb/ft³ = 233,956 lb = 117 tons
 = 106 tonnes.

Explosives per tonne of coal = 424 lb ANFO x (0.4536 kg/lb)/106 tonnes
 = 1.814 kg ANFO/tonne coal

Explosives Requirements: Black Beauty Coal Company, LLC. Wildcat Hills Mine, Cottage Grove Pit

Type of overburden material blasted: unspecified.

Overburden and interburden : 88.5 ft

Thickness of coal seam : 77.8 inches.

Hole diameter : 6¾ inches (Assumed)

Depth of hole : 88.5 ft (Assumed)

Powder factor : 0.026 lb/ft³ (Assumed)

Burden X Spacing : 20.75 ft x 20.75 ft

Explosives used : Bulk ANFO (Assumed)

Explosives weight per hole : 991 lb ANFO (14 lb/ft column)

Volume of coal exposed per blast hole = Area x Seam thickness
 $= 20.75\text{ft} \times 20.75\text{ft} \times (77.8/12)\text{ft} = 2791 \text{ ft}^3$

Amount of coal exposed per hole = 2791 ft³ x 84 lb/ft³ = 234,484 lb = 117 tons
 = 106 tonnes.

Explosives per tonne of coal = 991 lb ANFO x (0.4536 kg/lb)/106 tonnes
 = 4.241 kg ANFO/tonne coal

GREET results for light duty truck 2: Well-to-Wheel energy consumption and emissions (per mile) for gasoline

Item	Btu/mile or grams/mile		
	Feedstock	Fuel	Vehicle Operation
Total Energy	374	1,585	8,472
Fossil Fuels	360	1,458	8,349
Coal	65	269	0
Natural Gas	193	481	0
Petroleum	103	707	8,349
CO ₂ (w/ C in VOC & CO)	27	111	651
CH ₄	0.776	0.128	0.054
N ₂ O	0.001	0.007	0.012
GHGs	46	116	656

Energy densities, oxidation factors and emission factors for fossil fuels (EPA, 2005)

	Diesel*	Gasoline*	Propane
Carbon content (g/gallon)	2,778	2,421	
Energy content (mmBtu/gallon)	0.1295	0.1242	0.0735
Oxidation factor	0.99	0.99	1.00
CO ₂ emission (g/gallon)	10,084	8,788	7.3
CH ₄ emission (g/gallon)			0.00014
N ₂ O emission (g/gallon)			0.00017

GREET Well-To-Pump energy consumption and emissions per mmBtu of fuel delivered to fuel station pump

	Gasoline	Diesel	Propane
Total Energy (Btu)	231,256.21	193,718.00	115,700.36
WTP Efficiency	81.22%	83.80%	89.63%
Fossil Fuels (g)	214,619.37	190,215.00	114,144.14
Coal (g)	39,496.70	32,158.00	10,653.74
Natural Gas (g)	79,546.20	76,092.00	75,176.42
Petroleum (g)	95,576.47	81,966.00	28,313.97
CO ₂ (w/ C in VOC & CO) (g)	16,261.79	15,488.00	8,896.20
CH ₄ (g)	106.70	104.53	114.72
N ₂ O (g)	0.91	0.25	0.16
Total GHGs (g CO ₂ eq.)	19,199.52	18,175.00	11,810.35

GREET Well-To-Pump energy consumption and emissions for generation and delivery of 1 MMBtu of electricity in the US and three States

	US	Arizona	Illinois	Missouri
Total Energy ((Btu)	1,626,799	1,512,265	1,228,498	2,035,486
WTP Efficiency	38.1%	39.8%	44.9%	32.9%
Coal (g)	1,033,819	768,706	849,337	1,841,479
Natural Gas (g)	296,961	518,250	63,290	88,381
Petroleum	77,034	13,759	15,958	29,939
CO ₂ (w/ C in VOC & CO) (g)	220,251	192,223	176,365	309,536
CH ₄ (g)	288.974	297.677	205.006	351.024
N ₂ O (g)	3.010	2.606	1.978	3.167
Total GHG (g CO ₂ eq.)	227,788	199,840	181,666	318,546

Cradle-to-gate energy inputs for the production of 1 tonne of coal

	Mines A1&A2	Mine B	Mine C	Mine D
Electricity (Btu/tonne)	66,255.20	6,706.90		16,252.20
Diesel (Btu)	17,961.40	71,050.30	90,602.30	139,316.80
Gasoline (Btu/tonne)	1,214.10	1,290.00	1,745.30	1,290.00
Propane (Btu/tonne)	829.4			
Explosives (Btu/tonne)	5778	13505	22028	14824
Total (Btu/tonne)	92038	92552	114376	171683
Total (MJ/tonne)	97	98	121	181

APPENDIX B.
LAND USE IMPACTS CALCULATIONS

Timeline for land disturbance and completion of reclamation for Black Mesa and Kayenta facilities

Facilities	Acres Disturbed	Year of Disturbance	Year of Reclamation completion (Bond Release)
N14 Conveyor & Preparation facility	239	1969	2059
J28 Conveyor & Preparation facility	256	1969	2059
Construction and cable yards	9	1969	2059
Public coal load out facilities	14	1969	2059
Buildings	39	1969	2059
Scoria borrow pits	11	1969	2059
Black Mesa Mine facility (miscellaneous)	22	1969	2059
Black Mesa Pipeline Company facility	40	1969	2059
Train loading site and overland conveyor	88	1969	2059
Water supply wells x12	0.72	1969	2059
J3 solid waste Land fill (non-coal)	14.2	1970	2008
Existing mine haul roads	592.3	1970	2059
N3 Air strip	173	1977	1987
J6 Airstrip	173	1986	2059
69kV powerline between J21 and J27	9	1996	2059
Total	1680		

Land use impact from mine facilities at
Black Mesa and Kayenta

Year	Area Disturbed (Acres)	Area Ready for Bond Release (Acres)	Cumulative Area Disturbed (Acres)
1969	718.7		718.7
1970	606.3		1325.0
1971			1325.0
1972			1325.0
1973			1325.0
1974			1325.0
1975			1325.0
1976			1325.0
1977	173.0		1498.0
1978			1498.0
1979			1498.0
1980			1498.0
1981			1498.0
1982			1498.0
1983			1498.0
1984			1498.0
1985			1498.0
1986	173.0		1671.0
1987		173.0	1498.0
1988			1498.0
1989			1498.0
1990			1498.0
1991			1498.0
1992			1498.0
1993			1498.0
1994			1498.0
1995			1498.0
1996	9.0		1507.0
1997			1507.0
1998			1507.0
1999			1507.0
2000			1507.0
:			:
2059		0	1507.0
Sum	1680.02	173	135078.5
Acre-year/ton			0.00017
m²-year/tonne			0.75040

Land use impact from coal extraction at
Black Mesa and Kayenta

Year	Area Disturbed (Acres)	Area Ready for Bond Release (Acres)	Cumulative Area Disturbed (Acres)
1970	475		475
1971	475		950
1972	475		1425
1973	475		1901
1974	475		2376
1975	475		2851
1976	475		3326
1977	475		3801
1978	475		4276
1979	475		4751
1980	475		5226
1981	475		5702
1982	475		6177
1983	475		6652
1984	475		7127
1985	475		7602
1986	475		8077
1987	475		8552
1988	475		9028
1989	475		9503
1990	475	474	9504
1991	475	474	9504
1992	475	474	9505
1993	475	474	9506
1994	475	474	9507
1995	475	474	9508
1996	475	474	9509
1997	475	474	9510
1998	475	474	9511
1999	475	474	9511
2000	475	474	9512
2001	475	474	9513
2002	475	474	9514
2003	475	474	9515
2004	475	474	9516
2005	475	474	9517
2006	489	474	9531
2007	489	474	9546
2008	489	474	9560
2009	489	474	9575
2010	489	474	9589

Year	Area Disturbed (Acres)	Area Ready for Bond Release (Acres)	Cumulative Area Disturbed (Acres)
2011	489	474	9604
2012	489	474	9619
2013	489	474	9633
2014	489	474	9648
2015	489	474	9662
2016	489	474	9677
2017	489	474	9691
2018	489	474	9706
2019	489	474	9720
2020	489	474	9735
2021	489	474	9749
2022	489	474	9764
2023	489	474	9778
2024	489	474	9793
2025	489	474	9808
2026	489	474	9822
2027	489	474	9837
2028	489	474	9851
2029	489	474	9866
2030	489	474	9880
2031	489	474	9895
2032	489	474	9909
2033	489	474	9924
2034	489	474	9938
2035	489	474	9953
2036	489	474	9967
2037	489	474	9982
2038	489	474	9997
2039	489	474	10011
2040	489	474	10026
2041	489	474	10040
2042	489	474	10055
2043	489	474	10069
2044	489	474	10084
2045	489	474	10098
2046	489	474	10113
2047	94	474	9733
2048		474	9259
2049		474	8784
2050		474	8310
2051		474	7836

Year	Area Disturbed (Acres)	Area Ready for Bond Release (Acres)	Cumulative Area Disturbed (Acres)
2052		474	7362
2053		474	6887
2054		474	6413
2055		474	5939
2056		474	5465
2057		474	4990
2058		474	4516
2059		4516	0
SUM	37240	37240	740140
Acre-year/ton			0.00092
m²-year/tonne			4.11171

Land use impact from mine facilities at
Wild Cat Hills Mine -

Cottage Grove Pit

Year	Area Disturbed (Acres)	Area Ready for Bond Release (Acres)	Cumulative Area Disturbed (Acres)
2000	105.6		
2001			105.6
2002			106
2003			105.6
2004			105.6
2005			105.6
2006			105.6
2007			105.6
2008			105.6
2009			105.6
2010			105.6
2011			105.6
2012			105.6
2013			105.6
2014			105.6
2015			105.6
2016			105.6
2017			105.6
2018		105.6	0.0
SUM	105.6	105.6	1795.2
Acre-year/ton			0.00023
m²-year/tonne			1.04003

Land use impact from coal extraction at
Wild Cat Hills Mine -

Cottage Grove Pit

Year	Area Disturbed (Acres)	Area Ready for Bond Release (Acres)	Cumulative Area Disturbed (Acres)
2000			
2001	47.7		47.7
2002	47.7		95.5
2003	47.7		143.2
2004	47.7		191.0
2005	47.7		238.7
2006	47.7		286.5
2007	47.7	47.7	286.5
2008	47.7	47.7	286.5
2009	47.7	47.7	286.5
2010	47.7	47.7	286.5
2011	47.7	47.7	286.5
2012	23.5	47.7	262.2
2013		47.7	214.5
2014		47.7	166.7
2015		47.7	119.0
2016		47.7	71.3
2017		47.7	23.5
2018		23.5	0.0
SUM	548.7	548.7	3292.2
Acre-year/ton			0.00043
m²-year/tonne			1.90730

Land use impact from mine facilities at
Cottonwood Creek

Year	Area Disturbed (Acres)	Area Ready for Bond Release (Acres)	Cumulative Area Disturbed (Acres)
2000	42		42
2001			42
2002			42
2003			42
2004			42
2005			42
2006			42
2007			42
2008			42
2009			42
2010			42
2011			42
2012			42
2013		42	0
SUM	42	42	546
Acre-year/ton			0.00036
m²-year/tonne			1.62377

Land use impact from coal extraction at
Cottonwood Creek

Year	Area Disturbed (Acres)	Area Ready for Bond Release (Acres)	Cumulative Area Disturbed (Acres)
2003	3.7		3.7
2004	74.7		78.4
2005	74.7		153.0
2006	74.7		227.7
2007	74.7		302.4
2008	74.7		377.0
2009	74.7	74.7	377.0
2010	74.7	74.7	377.0
2011	33.6	74.7	336.0
2012		74.7	261.3
2013		74.7	186.7
2014		74.7	112.0
2015		74.7	37.3
2016		37.3	0.0
SUM	560.0	560.0	2829.6
Acre-year/ton			0.0019
m²-year/tonne			8.4151

Land use impact from mine facilities at
Hume

Year	Area Disturbed (Acres)	Area Ready for Bond Release (Acres)	Cumulative Area Disturbed (Acres)
2000	29.7		29.7
2001			30
2002			30
2003			30
2004			30
2005			30
2006			30
2007			30
2008			30
2009			30
2010			30
2011			30
2012			30
2013			30
2014			30
2015			30
2016			30
2017			30
2018			30
2019			30
2020			30
2021			30
2022			30
2023			30
2024			30
2025			30
2026			30
2027			30
2028			30
2029			30
2030			30
2031			30
2032			30
2033			30
2034		29.7	0
SUM	29.7	29.7	1009.8
Acre-year/ton			0.00057
m²-year/tonne			2.54499

Land use impact from coal extraction at
Hume

Year	Area Disturbed (Acres)	Area Ready for Bond Release (Acres)	Cumulative Area Disturbed (Acres)
2000	8.8		8.8
2001	16.1		25.0
2002	16.1		41.1
2003	16.1		57.2
2004	16.1		73.3
2005	16.1		89.4
2006	16.1	16.1	89.4
2007	16.1	16.1	89.4
2008	16.1	16.1	89.4
2009	16.1	16.1	89.4
2010	16.1	16.1	89.4
2011	16.1	16.1	89.4
2012	16.1	16.1	89.4
2013	16.1	16.1	89.4
2014	16.1	16.1	89.4
2015	16.1	16.1	89.4
2016	16.1	16.1	89.4
2017	16.1	16.1	89.4
2018	16.1	16.1	89.4
2019	16.1	16.1	89.4
2020	16.1	16.1	89.4
2021	16.1	16.1	89.4
2022	16.1	16.1	89.4
2023	16.1	16.1	89.4
2024	16.1	16.1	89.4
2025	16.1	16.1	89.4
2026	16.1	16.1	89.4
2027	16.1	16.1	89.4
2028	16.1	16.1	89.4
2029		16.1	73.3
2030		16.1	57.2
2031		16.1	41.1
2032		16.1	25.0
2033		16.1	8.8
2034		8.8	0.0
SUM	460.0	460.0	2556.5
Acre-year/ton			0.0014
m²-year/tonne			6.4433

APPENDIX C.

SENSITIVITY ANALYSIS CALCULATIONS

Effects of different scenarios on potential energy use impacts

	Energy Use Impact (MJ/tonne coal)			
	Mines A1&A2	Mine B	Mine C	Mine D
Base case	97	98	121	181
US Grid electricity	102	100	129	178
5% Electricity reduction	94	97	120	180
5% Diesel reduction	96	94	116	174

Percentage change in energy use impacts for different scenarios

	Percent Change in Energy Use Impact			
	Mines A1&A2	Mine B	Mine C	Mine D
Base case	0	0	0	0
US Grid electricity	5.5	2.3	7.1	-1.9
5% Electricity reduction	-3.6	-0.4	-0.3	-0.5
5% Diesel reduction	-1.0	-3.8	-4.0	-4.1

Effects of different scenarios on potential resource depletion impacts

	Resource Depletion Impact (kg Sb-eq./tonne coal)			
	Mines A1&A2	Mine B	Mine C	Mine D
Base case	7.80	8.06	8.38	9.38
US Grid electricity	7.73	8.10	8.40	9.38
5% Electricity reduction	7.77	8.06	8.38	9.37
5% Diesel reduction	7.79	8.00	8.31	9.25

Percentage change in abiotic resource depletion impacts for different scenarios

	Percent Change In Resource Depletion Impact			
	Mines A1&A2	Mine B	Mine C	Mine D
Base case	0	0.00	0.00	0.00
US Grid electricity	-1.0	0.5	0.2	0.0
5% Electricity reduction	-0.5	0.0	-0.1	-0.1
5% Diesel reduction	-0.2	-0.8	-0.9	-1.3

Effects of different scenarios on potential climate change impacts

	Climate Change Impact (kg CO2 -eq.)			
	Mines A1&A2	Mine B	Mine C	Mine D
Base case	37.9	53.9	65.4	91.5
US Grid electricity	39.1	54.1	64.2	90.8
5% Electricity reduction	37.5	53.8	64.9	91.4
5% Diesel reduction	37.4	52.1	63.1	88.1
5% Coalbed methane reduction	37.0	53.2	64.5	90.7

Percentage change in climate change impacts for different scenarios

	Percent Change in Climate Change Impact			
	Mines A1&A2	Mine B	Mine C	Mine D
Base case	0	0.00	0.00	0.00
US Grid electricity	3.2	0.5	-1.7	-0.8
5% Electricity reduction	-1.2	-0.1	-4.9	-0.1
5% Diesel reduction	-1.2	-3.3	-3.4	-3.8
5% Coalbed methane reduction	-2.3	-1.4	-1.3	-0.9

APPENDIX D.

GLOSSARY OF LCA RELATED TERMS

Abiotic Depletion Potential (ADP)	Characterization factor for the depletion of an abiotic resource based on ultimate reserves and extraction rate, and which expresses the indicator results for abiotic resource depletion in kg of a reference resource (antimony) (Guinée, 2002).
Abiotic resource depletion	Consumption of non-renewable resources resulting in the lowering of their availability for future generations (EC JRC, 2010).
Attributional LCA	Also retrospective or descriptive LCA. An LCA that accounts for flows/impacts of pollutants, resources, and exchanges among processes within a chosen temporal window (EPA, 2006).
Average data	LCA data representing the average environmental burdens for producing a unit of product or service from a system (Ekvall et al., 2005).
Carbon dioxide-equivalent (CO₂-eq)	The concentration of CO ₂ that would cause the same amount of radiative forcing as a given mixture of CO ₂ and other greenhouse gases (IPCC, 2001).
Characterization	The second mandatory element of the impact assessment phase of LCA in which the inventory flows are used to calculate the magnitudes of the impact category indicator results (Guinée, 2002).
Characterization Factor	Also called Equivalency factor. A factor derived from a characterization model which is applied to convert the assigned LCI results to the common unit of the category indicator. It is an indicator of the potential of each chemical to impact the given environmental impact category in comparison to the reference chemical used. (EPA, 2006).
Classification	The first mandatory element of the impact assessment phase of LCA in which the LCI results are assigned to impact categories (Guinée, 2002).

Climate change	A change of climate which is attributed directly or indirectly to human activity that alters the composition of the global atmosphere and which is in addition to natural climate variability observed over comparable time periods (IPCC, 2001).
Climate change impacts	The effects of climate change on natural and human systems (IPCC, 2007).
Cradle-to-gate assessment	A streamlined LCA in which the system boundaries exclude the use and waste treatment stage (Baumann and Tillman, 2004).
Cradle-to-grave assessment	A "cradle-to-grave" analysis considers impacts at each stage of a product's life-cycle, from the time natural resources are extracted from the ground and processed through each subsequent stage of manufacturing, transportation, product use, recycling, and ultimately, disposal (EU, 2010).
Cut-off criteria	Specification of amount of material or energy flow or level of environmental significance associated with unit processes or product system to be excluded from the study (ISO 14040, 1997).
Data quality analysis	The optional element of the impact assessment phase in which the quality of the LCA input data and results are analyzed to enhance understanding of the significance, uncertainty and sensitivity of the LCIA results (Guinée, 2002).
Design for Environment	Design for Environment (DfE) or Eco-design is a method supporting product developers in reducing the total environmental impact of a product early in the product development process. This includes reducing resource consumption as well as emissions and waste (EC JRC, 2010).
Eco-labeling	A voluntary, multiple-criteria-based third party program that awards a license which authorizes the use of environmental labels on products, indicating overall environmental preference of a product within a particular product category based on life cycle assessment (Baumann and Tillman, 2004).

Endpoint modeling method	The endpoint modeling method (or damage approach) tries to model the effects of emissions directly for the protection targets (natural environment's ecosystems, human health, resource availability). Endpoint methods typically follow the midpoint modeling considering the severity and reversibility of effects and the models' uncertainties (EC JRC, 2010).
Energy intensity	Energy intensity is the ratio of energy use to economic or physical output (IPCC, 2007).
Environmental flows	Inputs from and outputs to the environment (Guinée, 2002).
Environmental product declaration	An internationally standardized (ISO 14025) and LCA based method to communicate the environmental performance of a product or service (EC JRC, 2010).
Functional unit	Defines the quantification of the specified function(s) fulfilled by a product and serves as a reference flow for calculating the inputs and outputs of the system (ISO 14041, 1998).
Gate-to-gate assessment	Also called environmental accounting or auditing. It is a streamlined LCA in which only data within a facility is considered in the assessment and upstream and downstream life cycle stages are eliminated (Todd, 1996).
Global Warming Potential (GWP)	An index approximating the time-integrated warming effect of a unit mass of a given greenhouse gas in today's atmosphere, relative to that of carbon dioxide (IPCC, 2001).
Goal and scope definition	The first phase of LCA stating the aim of an intended LCA study, the functional unit, the system alternatives considered, and the breadth and depth of the intended LCA study (Guinée, 2002).
Greenhouse gas	Gaseous constituents of the atmosphere, both natural and anthropogenic, that absorb and emit radiation at specific wavelengths within the spectrum of infrared radiation emitted by the Earth's surface, the atmosphere and clouds (IPCC, 2001).

Grouping	An optional element of the impact assessment phase of LCA in which the impact category indicators are grouped into one or more sets involving descriptive sorting or priority ranking (Guinée, 2002).
Impact category	Class representing environmental issue of concern. E.g. Climate change, Acidification, Ecotoxicity etc. (ISO 14042, 2000). Classification of human health and environmental effects caused by a product throughout its life cycle (EPA, 2006).
Impact indicators	Impact indicators measure the potential for an impact to occur rather than directly quantifying the actual impact (EPA, 2006).
Improvement assessment	A systematic evaluation of the needs and opportunities to reduce the environmental burdens associated with energy and raw material use and environmental releases throughout the whole life cycle of a product, process, or activity (Curran, 1996).
Integrated product policy (IPP)	Approach founded on the consideration of the impacts of products throughout their life-cycle to improve the environmental performance of products in a cost-effective way (EC JRC, 2010).
Interpretation	The last phase of LCA involving the identification of significant issues based on the results of the LCI and the LCIA phase of LCA, and in which conclusions, recommendations and reporting are done (Guinée, 2002).
Life Cycle Assessment (LCA)	A compilation and evaluation of inputs, outputs and potential environmental impacts of a product system throughout its life cycle (ISO 14040, 1997).
Life Cycle Impact Assessment (LCIA)	The phase of LCA in which individual data in the inventory table or LCI results are translated into contributions to selected impact categories. LCIA is a quantitative and/or qualitative process to identify, characterize and assess the potential impacts of the environmental interventions identified in the inventory analysis (Guinée, 2002).

Life Cycle Inventory Analysis (LCI)	The phase of life cycle assessment involving the compilation and quantification of inputs and outputs for a given product system throughout its life cycle (ISO 14040:1997).
Kyoto Protocol	The Kyoto Protocol to the United Nations Framework Convention on Climate Change (UNFCCC) was adopted at the Third Session of the Conference of the Parties (COP) to the United Nations Framework Convention on Climate Change, in 1997 in Kyoto, Japan (IPCC, 2001).
Land use impact	The impact category related to use (occupation) and conversion (transformation) of land area by product-related activities such as agriculture, roads, housing, mining etc. Land occupation considers the effects of the land use, the amount of area involved and the duration of its occupation (quality-changes multiplied with area and duration). Land transformation considers the extent of changes in land properties and the area affected (quality changes multiplied with the area) (EC JRC, 2010).
Life cycle thinking	A way of thinking that considers the cradle-to-grave implications of different activities without going into the details of an LCA study (Baumann and Tillman, 2004).
Lifetime	A general term used for various time-scales characterizing the rate of processes affecting the concentration of trace gases (IPCC, 2001).
Marginal Data	LCA data which corresponds to the effects on the environmental burdens of a system due to a small change in the output of a product (Ekvall et al., 2005).
Mid-point modeling method	A modeling method which specifies the results of traditional LCIA characterization methods as indicators located between emission and endpoint damages in the impact pathway at the point where it is judged that further modeling involves too much uncertainty (EC JRC, 2010).

Normalization	An optional element of the impact assessment phase of LCA which involves calculations of the magnitudes of impact category indicators relative to reference information (Guinée, 2002).
Potential Impacts	Modeled impacts as opposed to measured impacts (Guinée, 2002).
Products	Physical goods as well as services (Guinée, 2002).
Product system	A collection of unit processes connected by flows of intermediate products which perform one or more defined functions (ISO 14041, 1998).
Prospective LCA	Also known as effect-oriented or consequential LCA. It is an LCA that aims to describe the consequences of changes made within the technological system investigated (Ekvall et al., 2005).
Stand-alone LCA	An LCA used to describe a single product, often in an exploratory way, in order to get acquainted with some important environmental characteristics of that product (Baumann and Tillman, 2004).
Streamlined LCA	An LCA that focuses on a few critical dimensions of the product's environmental impacts, rather than all dimensions, or an LCA in which some life cycle stages have been limited or eliminated (Todd, 1996).
Sustainability reporting	The process for publicly disclosing an organization's economic, environmental, and social performance (EC JRC, 2010).
Unit process	A unit process is any kind of activity producing economically valuable material, component or product, or providing an economically valuable service, and it is the smallest portion of a product system for which data is collected during the execution of an LCA (Guinée, 2002). Unit processes are linked to one another by flows of intermediate products and/or waste, to other product

systems by product flows, and to the environment by elementary flows (i.e. inputs from and outputs to the environment) (ISO 14040, 1997).

Weighting

An optional element of the impact assessment phase of LCA in which the indicator results or normalized results are multiplied by numerical factors to convert and possibly aggregate indicator results across impact categories into a single score or a small number of scores (Guinée, 2002).

BIBLIOGRAPHY

- Ahmadi, A., Williamson, B.H., Theis, T.L., and Powers S.E. (2003). Life-cycle Inventory of Toner Produced for Xerographic Processes. *Journal of Cleaner Production*, 11 (2003), Elsevier Science Ltd, pp. 573–582.
- Aimone, C. T. (1992). Blast Design. In: Hartman, H. L. (Ed.), *SME Mining Engineering Handbook*, Vol. 1, 2nd Edition, Society for Mining Metallurgy, and Exploration, Inc., Littleton, Colorado, USA, pp. 722-746.
- Andræ, A.S.G., Andersson, D.R. and Liu, J (2005). Significance of Intermediate Production Processes in Life Cycle Assessment of Electronic Products Assessed Using A Generic Compact Model. *Journal of Cleaner Production*, Vol. 13 (2005), Elsevier Science Ltd, pp. 1269 -1279.
- Arclar (2009). Application for Surface Coal Mining and Reclamation Operations Permit-Surface Operations SCM-1 - Wildcat Hills Mine, Cottage Grove Pit, Application #403. Arclar Company, LLC, March 7, 2009. Retrieved on 11/07/2009 from Illinois Department of Natural Resources website at <http://www.dnr.state.il.us/mines/lrd/lrddecisions/p403mods.pdf>.
- Argonne (2009). The Greenhouse Gases, Regulated Emissions, and Energy Use in Transportation (GREET) Model. UChicago Argonne, LLC. Retrieved on 02/10/2010 from the US Department of Energy's Argonne National Laboratory website at http://www.transportation.anl.gov/modeling_simulation/GREET/.
- Awuah-Offei, K., Checkel D. and Askari-Nasab. (2008). Evaluation of belt conveyor and truck haulage systems in an open pit mine using life cycle assessment, *CIM Bulletin*, Vol. 102, No 1115, Paper 8, pp. 1-6.
- Ayres, R. U. (1995). Life cycle analysis: A critique. *Resources, Conservation and Recycling*, Vol. 14, Nos. 3-4, Elsevier B.V., pp. 199-223.
- Babbitt C. W. and Lindner, A. S. (2005). A Life Cycle Inventory of Coal Used for Electricity Production in Florida. *Journal of Cleaner Production*, Vol. 13, No. 9, Elsevier Ltd, pp. 903 – 912.
- Babbitt C. W. and Lindner, A. S. (2008). A Life Cycle Comparison of Disposal and Beneficial Use of Coal Combustion Products in Florida Part 1: Methodology and Inventory of Materials, Energy, and Emissions. *Int. J. LCA*, Vol. 13, No. 3, Springer-Verlag, pp. 202 – 211.

- Bare, J., Gloria, T. and Norris, G. (2006). Development of the Method and U.S. Normalization Database for Life Cycle Impact Assessment and Sustainability Metrics. *Environmental Science & Technology*, Vol. 40, No. 16, 2006, American Chemical Society, pp. 5108-5115.
- Basset-Mens, C., van der Werf, H.M.G., Robin, P., Morvan, Th., Hassouna, M., Paillat, J.-M., and Vertès, F. (2007). Methods and Data for the Environmental Inventory of Contrasting Pig Production Systems. *Journal of Cleaner Production*, 15 (2007), Elsevier Ltd, pp. 1395-1405.
- Basu, A.J. and Carabias-Hütter, V. (2004). Indicators For Sustainability Assessment And Reporting. SME Annual Meeting, Feb. 23-25, 2004 Denver, Colorado.
- Battisti, R. and Corrado, A. (2005). Environmental Assessment of Solar Thermal Collectors With Integrated Water Storage. *Journal of Cleaner Production*, 13 (2005), Elsevier Science Ltd, pp. 1295-1300.
- Baumann, H. and Tillman A. (2004), *The Hitch Hiker's Guide to LCA: An orientation in Life Cycle Assessment Methodology And Application*, Studentlitteratur, Lund, Sweden.
- Baur, C. and Zapp, P. (2005). Towards Generic Characterisation Factors for Land Use and Water Consumption. In: Dubreuil, A. (Ed.), *Life-Cycle Assessment of metals: Issues and Research Direction*, Proceedings of the International Workshop on Life-Cycle Assessment And Metals, April 2002, SETAC, Raleigh, North Carolina, USA, pp.147-152.
- Bayer, P. and Finkel, M. (2006). Life cycle assessment of active and passive groundwater remediation technologies. *Journal of Contaminant Hydrology*, 83 (2006), Elsevier B.V., pp. 171– 199.
- Benetto, E., Dujet, C. and Rousseaux, P. (2006). Fuzzy-Sets Approach to Noise Impact Assessment. *Int. J. LCA*, Vol. 11, No. 4, Ecomed publishers, Landsberg, Germany, pp. 222-228.
- Berkhout, F. and Howes, R. (1997). The Adoption of Life-cycle Approaches by Industry: Patterns and Impacts. *Resources, Conservation and Recycling*, Vol. 20, No. 2, Elsevier Sci B.V., pp. 71-94.
- BHP Billiton (2008). *Resourcing the Future: Sustainability Report 2008 – Full Report*. Accessed on 01/06/2010 at BHP Billiton website at http://www.bhpbilliton.com/bbContentRepository/docs/bhpb_sustainability_2008.pdf.

- Bogunovic, D. and Kecojevic, V. (2009). Equipment CO₂ Emissions in Surface Coal Mining. *Int. J. Mining and Mineral Engineering*, Vol. 1, no. 2, 2009, Inderscience Enterprises, pp.172-180.
- Bond, A.J., Viegas, C.V., Coelho, C.C.R. and Selig, P.M. (2010). Informal Knowledge Processes: The Underpinning for Sustainability Outcomes in EIA? *Journal of Cleaner Production* 18 (2010), Elsevier Ltd, pp. 6-13.
- Bourassa, A. (2005). The Environmental Impact of Producing Nonrenewable Resources: The Case for Mining. In: Dubreuil, A. (Ed.), *Life-Cycle Assessment of metals: Issues and Research Direction, Proceedings of the International Workshop on Life-Cycle Assessment And Metals*, April 2002, SETAC, Raleigh, North Carolina, USA, pp.132-137.
- Bovea, M.D., Saura, Ú., Ferrero, J.L. and Giner, J. (2007). Cradle-to-Gate Study of Red Clay for Use in the Ceramic Industry. *Int. J. LCA*, Vol. 12 No. 6, Ecomed Publishers, Landsberg, Germany, pp. 439–447.
- Buxmann, K. (2005). LCA of Aluminium Products: Key Features. In: Dubreuil, A. (Ed.), *Life-Cycle Assessment of metals: Issues and Research Direction. Proceedings of the International Workshop on Life-Cycle Assessment And Metals*, April 2002, SETAC, Raleigh, North Carolina, USA, pp.68-72.
- Cadotte, M., Deschênes, L. and Samson, R. (2007). Selection of a Remediation Scenario for a Diesel Contaminated Site Using LCA. *Int. J. LCA*, Vol. 12. No. 4, Ecomed Publishers, Landsberg, Germany, pp. 239-251.
- Canals, L.M., Bauer, C., Depestele, J., Dubreuil, A., Knuchel, R.F., Gaillard, G., Michelsen, O., Müller-Wenk, R. and Rydgren, B. (2007). Key Elements In A Framework For Land Use Impact Assessment Within LCA. *Int. J. LCA*, Vol. 12, No.1, Ecomed Publishers, Landsberg, Germany, pp. 5–15.
- Carpenter, A. (2009). Sustainable Management of Industrial Capital: LCA and Spatial Analysis in Decision Making for Beneficial Use of Industrial By-products. Ph.D. dissertation, University of New Hampshire, United States - New Hampshire. Retrieved March 24, 2010, from Dissertations & Theses: A&I.(Publication No. AAT 3363712).
- Carpenter, S. M. and Hairfield, C.R. (2010). Fundamentals of Carbon Regulations and Their Impacts on the Mining Industry. SME, SME Annual Meeting, Feb. 28-Mar. 03, 2010, Phoenix, AZ, USA, p.4
- Caterpillar Inc. (2008). *Caterpillar Performance Handbook*. Edition 38, Peoria, Illinois, U.S.A.

- CBO. (2009). The Economic Effects of Legislation to Reduce Greenhouse-Gas Emissions. October 2009. Congressional Budget Office, Washington, D.C. Retrieved on 02/03/2010 at <http://www.cbo.gov/ftpdocs/105xx/doc10561/10-14-Greenhouse-GasEmissions.pdf>.
- Cheskidov, V.I., Kortelev, O.B., Aleksandrov, A.N. and Il'bul'din, D. K. (2004). Estimation Criteria for Energy Consumption by Mining Equipment in Quarries. *Journal of Mining Science*, Vol. 40, No.4, Springer Science + Business Media, Inc. pp. 380-383.
- Chevalier, J. L. and Le Téno, J.F. (1996). Life Cycle Analysis With Ill-defined data and Its Application to Building Products. *Int. J. LCA* Vol. 1, No.2, Ecomed Publishers, Landsberg, Germany, pp. 90-96.
- Chinh, L. D., Gheewala, S. H. and Bonnet, S. (2007). Integrated environmental assessment and pollution prevention in Vietnam: the case of anthracite production. *Journal of Cleaner Production*, Vol. 15, No. 18, Elsevier Ltd, pp. 1768-1777.
- Consoli, F., Allen, D., Boustead, I., Fava, J., Franklin, W., Jensen, A.A., de Oude, N., Parrish, R., Perriman, R., Postlethwaite, D., Quay, B., Sie' guin, J., Vigon, B. (Eds.), (1993). *Guidelines for Life Cycle Assessment. A Code of Practice*. SETAC Press, Pensacola, FL, USA.
- Continental Coal. (2009). Application for Surface Coal Mining Permit – Cottonwood Creek Mine, Permit No. 2003-01E – Expansion. Continental Coal Inc. January 25, 2009. Accessed in 08/27/2009 at the Missouri Department of Natural Resources offices in Rolla, MO, USA.
- Charles A. Cravotta, C. A. (2003). Ecosystem Restoration Size and Performance of Anoxic Limestone Drains to Neutralize Acidic Mine Drainage. *Journal of Environmental Quality*. Vol. 32 (2003). pp.1277–1289.
- Curran, M. A. (1996). The History of LCA. In: Curran M. A. (Ed.), *Environmental Life-cycle Assessment*, McGraw-Hill, New York, NY, USA.
- Curran, M.A., Mann, M. and Norris, G.(2005). Note from the field: The International Workshop on Electricity Data for Life Cycle Inventories. *Journal of Cleaner Production*. Vol. 13 (2005), Elsevier Ltd, pp. 853-862.
- Czaplicka-Kolarz, K., Wachowicz, J. and Bojarska-Kraus, M. (2004). A Life Cycle Method for Assessment of a Colliery's Eco-indicator. *Int. J. LCA*, Vol. 9, No. 4. Ecomed publishers, Landsberg, Germany, pp. 247-253.

- Day, S. J., N. Carras, J.N., Fry, R. and Williams, D.J. (2009). Greenhouse Gas Emissions From Australian Open-Cut Coal Mines: Contribution From Spontaneous Combustion And Low-Temperature Oxidation. Environmental Monitoring Assessment. Published online 27 June 2009, DOI 10.1007/s10661-009-1021-7, Springer Science + Business Media B.V.
- De Marco, O., Lagioia, G., Amicarelli, V. and Sgaramella, A. (2009) Constructing Physical Input-Output Tables with Material Flow Analysis (MFA) Data: Bottom-Up Case Studies. In: Suh, S. (Ed), Handbook of Input-Output Economics in Industrial Ecology, Volume 23, Springer, Netherlands.
- den Boer, J., den Boer, E. and Jager, J. (2007). LCA-IWM: A Decision Support Tool for Sustainability Assessment of Waste Management Systems. Waste Management, 27 (2007), Elsevier Ltd, pp. 1032–1045.
- Dinca C., Rousseaux, P. and Badea, A. (2007). A life Cycle Impact of the Natural Gas used in the Energy Sector in Romania. Journal of Cleaner Production, 15 (2007), Elsevier Ltd, pp. 1451-1462.
- DOE. (2004). Advanced Petroleum Based Fuels - Diesel Emissions Control (APBF-DEC)- Lubricants Project Phase 1 Final Report. US Department of Energy. July 2004. Retrieved on 02/23/2010 at http://www.nrel.gov/vehiclesandfuels/apbf/pdfs/dec_lub_ph1_report.pdf.
- DOE (2007). Mining Industry Energy Bandwidth Study. US Depart of Energy, Industrial Technologies Program. June 2007. Retrieved on 05/02/2010 at http://www1.eere.energy.gov/industry/mining/pdfs/mining_bandwidth.pdf.
- DOE (2009a). Financial Assistance Funding Opportunity Announcement: Biomass Research and Development Initiative Funding Opportunity Number DE-PS36-09GO99016, Department of Energy, Golden, Colorado.
- DOE (2009b), Well-to-Wheels Energy Use and Greenhouse Gas Emissions Analysis of Plug-in Hybrid Electric Vehicles. U.S. Department of Energy, ANL/ESD/09-2, Argonne, Illinois, USA. Accessed on 09/26/2009 at <http://www.transportation.anl.gov/pdfs/TA/559.pdf>
- Durucan, S., Korre, A. and Munoz-Melendez, G. (2006). Mining Life Cycle Modelling: A Cradle-To-Gate Approach To Environmental Management In The Minerals Industry. Journal of Cleaner Production, 14 (2006), Elsevier Ltd, pp. 1057-1070.
- EC JRC. (2010). Our Thinking Life Cycle Thinking. European Commission Join Research Center - Institute for Environment and Sustainability. Retrieved on June 26, 2010 from the Institute for Environment and Sustainability website at http://lct.jrc.ec.europa.eu/index_jrc.

- EIA (2001). Biomass for Electricity Generation. Energy Information Administration. Retrieved on 02/05/2010 from the Energy Information Administration website at <http://www.eia.doe.gov/oiaf/analysispaper/biomass/pdf/biomass.pdf>.
- EIA (2009a). Electric Power Monthly: March 2009. DOE/EIA-0226 (2009/03), Energy Information Administration, Washington, DC, accessed on 09/19/2009 at EIA website <http://tonto.eia.doe.gov/ftproot/electricity/epm/02260903.pdf>.
- EIA (2009b). Annual Coal Report 2008. DOE/EIA-0584 (2008). U.S. Energy Information Administration. Washington, DC. September 2009. Retrieved on 09/19/2009 at <http://www.eia.doe.gov/cneaf/coal/page/acr/acr.pdf>.
- EIA (2009c). Annual Energy Outlook 2009: With Projections to 2030. DOE/EIA-0383(2009), Energy Information Administration, Washington, DC, accessed on 11/20/2009 at website, [http://www.eia.doe.gov/oiaf/archive/aeo09/pdf/0383\(2009\).pdf](http://www.eia.doe.gov/oiaf/archive/aeo09/pdf/0383(2009).pdf).
- EIA (2009d). Annual Energy Review 2008. DOE/EIA-0384(2008). June 2009. Energy Information Administration, Washington, DC. Accessed on 06/20/2009 at website <http://www.eia.doe.gov/aer/pdf/aer.pdf>.
- EIA(2010). Coal News and Markets: Average Weekly Coal Commodity Spot Prices. January 8, 2010. US Energy Information Administration. Retrieved on 01/26/2010 at <http://www.eia.doe.gov/coal/page/coalnews/coalmar.html>.
- Ekvall, T. (2005). SETAC Summaries. Journal of Cleaner Production 13 (2005), Elsevier Ltd, pp. 1351-1358.
- Ekvall, T., Tillman, A.-M. and Molander, S. (2005). Normative Ethics and Methodology for Life Cycle Assessment. Journal of Cleaner Production 13 (2005), Elsevier Ltd, pp. 1225-1234.
- EPA.(1994). Acid Mine Drainage Prediction: Technical Document, EPA 530-R-94-036/NTIS PB94-201829, December 1994, U.S. Environmental Protection Agency, Washington, DC. Accessed from EPA website on the 02/16/2010 at <http://www.epa.gov/waste/nonhaz/industrial/special/mining/techdocs/amd.pdf>.
- EPA (1998). Guidelines for Ecological Risk Assessment. EPA/630/R-95/002F U.S. Environmental Protection Agency, April 1998, Washington, DC. Retrieved on 01/26/2010 at <http://www.epa.gov/raf/publications/pdfs/ECOTXTBX.PDF>.
- EPA (2005). Emission Facts: Average Carbon Dioxide Emissions Resulting from Gasoline and Diesel Fuel. EPA420-F-05-001, February 2005. Retrieved on 09/03/2009 at <http://www.epa.gov/oms/climate/420f05001.htm>.

- EPA (2006), Life Cycle Assessment: Principles and Practice. U.S. Environmental Protection Agency EPA/600/R-06/060, Cincinnati, Ohio, USA. Accessed on 10/12/2008 at EPA website at <http://www.epa.gov/NRMRL/lcaccess/pdfs/600r06060.pdf>.
- EPA. (2009). The Emissions & Generation Resource Integrated Database: eGRID2007 Version 1.0. US Environmental Protection Agency Office of Atmospheric Programs Climate Protection Partnerships, Division, EP-D-06-001, April 2009, Washington, DC. Accessed On 03/24/2010 at <http://www.epa.gov/egrid>.
- EU Ecolabel (2010). What is Ecolabel? Accessed on 02/27/2010 at the European Union Ecolabel website at http://ec.europa.eu/environment/ecolabel/about_ecolabel/what_is_ecolabel_en.htm.
- Fast, S. (2008). A Life Cycle Assessment (LCA) of the Potential for Biofuels to Reduce Greenhouse Gas Emissions and Fossil Fuel Consumption: Comparative Assessment of Two Regions in Ontario, Canada. M.A. dissertation, Carleton University (Canada), Canada. Retrieved 03/24/2010, from Dissertations & Theses: A&I. (Publication No. AAT MR47498).
- Finkbeiner, M., Hoffmann, R., Ruhland, K., Liebhart, D. and Stark, B. (2006). Application of Life Cycle Assessment for the Environmental Certificate of the Mercedes-Benz S-Class. *Int. J. LCA* , Vol. 11, No. 4, Ecomed publishers, Landsberg, Germany, pp. 240 – 246.
- Finnveden, G. and Lindfors, L. (1998). Data Quality of Life Cycle Inventory Data: Rules of Thumb. *Int. J. LCA*, Vol. 3, No. 2, Ecomed publishers, Landsberg, Germany, pp. 65-66.
- Finnveden, G. (2008). A world With CO2 Caps: Electricity Production in Consequential Assessments. *Int. J. Life Cycle Assess* 13 (2008), Springer-Verlag, pp.365–367
- Finnveden, G., Hauschild, M.Z., Ekvall, T., Guinée, J., Heijungs, R., Hellweg, S., Koehler, A., Pennington, D. and Suh, S. (2009). Recent Developments in Life Cycle Assessment. *Journal of Environmental Management* 91 (2009), Elsevier Ltd, pp.1–21.
- Frischknecht, R. and Rebitzer, G. (2005). The Ecoinvent Database System: A Comprehensive Web-Based LCA Database. *Journal of Cleaner Production*, 13 (2005), Elsevier Ltd, pp.1337-1343.
- Froese, R. E., Shonnard, D. R., Miller, C. A., Koers, K. P., Johnson, D. M. (2010). An evaluation of greenhouse gas mitigation options for coal-fired power plants in the US Great Lakes States. *Biomass and Bioenergy*, Vol. 34, No. 3, Elsevier Ltd, pp. 251-262.

- Gäbel, K. and Tillman, A.M. (2005). Simulating Operational Alternatives For Future Cement Production *Journal Of Cleaner Production*, 13 (2005), Elsevier Ltd, pp. 1246-1257.
- Giurco, D. and Petrie, J.G. (2007). Strategies for Reducing The Carbon Footprint of Copper: New Technologies, More Recycling Or Demand Management?. *Minerals Engineering*, Vol. 20 (2007), Elsevier Ltd, pp. 842–853.
- Global Footprint Network (2009). Footprint Basics – Overview. Accessed on 02/26/2010 at Global Footprint Network' s website at <http://www.footprintstandards.org/>.
- González, B., Adenso-Díaz, B. and González-Torre, P.L. (2002), A Fuzzy Logic Approach for the Impact Assessment in LCA. *Resources, Conservation and Recycling*, 37 (2002), Elsevier Science B.V., pp. 61-79.
- Gorree, M., Guinée, J.B., Huppes, G. and van Oers, L. (2000) Environmental Life Cycle Assessment of Linoleum - final report. Centre of Environmental Science – Leiden University, June 2000, Leiden, Netherlands.
- Guinée, J.B. (Ed.) (2002). Handbook on Life Cycle Assessment: Operational Guide to ISO Standards, Kluwer Academic Publishers, Secaucus, NJ, USA. p. 705.
- Hales D. and Prescott-Allen, R. (2002). Flying Blind: Assessing Progress Toward Sustainability, in *Global Environmental Governance Options & Opportunities*. In: Esty, D.C and Ivanova, M.H. (Eds.), *Global Environmental Governance: Options and Opportunities*, Yale School of Forestry & Environmental Studies. Accessed on 01/16/2010 at www.yale.edu/environment/publications.
- Hansen, Y., Notten, P.J. and Petrie, G. (2002). A Life Cycle Impact Assessment Indicator For Ash Management In Coal-Based Power Generation. *Journal of the South African Institute of Mining and Metallurgy*, Vol. 102, No. 5, July/August 2002, South African Institute of Mining and Metallurgy pp. 299-306.
- Hendrickson, C.T., Lave, L. B. and Matthews, H. S. (2006). Environmental Life Cycle Assessment of Goods and Services: An Input-Output Approach. Resources for the future, Washington DC, USA.
- Höjer, M., Ahlroth, S., Dreborg, K.-H., Ekvall, T., Finnveden, G., Hjelm, O., Hochschorner, E., Nilsson, M. and Palm, V. (2008). Scenarios in Selected Tools for Environmental Systems Analysis. *Journal of Cleaner Production* 16 (2008), Elsevier Ltd, pp. 1958-1970.
- Hoskins, W. (2005). UNEP's Role as Facilitator in the UNEP/SETAC Life-Cycle Initiative to Enhance the Use of LCA. In: Dubreuil, A. (Ed.), *Life-Cycle Assessment of metals: Issues and Research Direction*. Proceedings of the International Workshop on Life-Cycle Assessment And Metals, April 2002, SETAC, Raleigh, North Carolina, USA, pp.5-8.

- Huijbregts, M.A.J., Norris, G., Bretz, R., Ciroth, A., Maurice, B., von Bahr, B., Weidima, B., de Beaufort, A.S.H. (2001). Framework For Modeling Data Uncertainty in Life Cycle Inventories. *Int. J. LCA* Vol. 6, No. 3, Ecomed Publishers, Landsburg, Germany, pp. 127-132.
- Hunkeler, D. and Rebitzer, G. (2005). The Future of Life Cycle Assessment. *Int. J. LCA*, Vol. 10, No. 5, Ecomed publishers, Landsberg, Germany, pp. 305 – 308.
- IAI. (2003). Life Cycle Assessment Of Aluminium: Inventory Data For The Worldwide Primary Aluminium Industry, accessed on 02/26/2010 at International Aluminium Institute website at http://greenbuilding.world-aluminium.org/uploads/files/09/Global_LCI_Report.pdf.
- IAIA. (2009). Principles of Environmental Impact Assessment Best Practice. Accessed on 02/03/2010 at International Association For Impact Assessment website <http://www.iaia.org/>.
- Infomine (2009). Mine and Mill Equipment Cost. Infomine USA Inc.
- IPCC. (2001). Climate Change 2001: The Scientific Basis. Contribution of Working Group I to the Third Assessment Report of the Intergovernmental Panel on Climate Change. [Houghton, J.T., Ding, Y., Griggs, D.J., Noguer, M., van der Linden, P.J., Dai, X., Maskell, K. and Johnson, C.A. (Eds.)]. Cambridge University Press, Cambridge, United Kingdom and New York, NY, USA, 881pp.
- IPCC. (2007). Climate Change 2007: The Physical Science Basis. Contribution of Working Group I to the Fourth Assessment Report of the Intergovernmental Panel on Climate Change. [Solomon, S., Qin, D., Manning, M., Chen, Z., Marquis, M., Averyt, K.B., Tignor, M. and Miller, H.L. (Eds.)]. Cambridge University Press, Cambridge, United Kingdom and New York, NY, USA, 996 pp.
- ISO. (1997). ISO 14040 Environmental Management - Life Cycle Assessment – Principles and Framework. International Organization for Standardization, Geneva, Switzerland.
- ISO. (1998). ISO 14041 Environmental Management - Life Cycle Assessment – Goal and Scope Definition and Inventory Analysis. International Organization for Standardization, Geneva, Switzerland.
- ISO. (2000). ISO 14042 Environmental Management - Life Cycle Assessment – Life Cycle Impact Assessment. International Organization for Standardization, Geneva, Switzerland.
- ISO. (2006a). ISO 14040 Environmental Management – Life Cycle Assessment – Principles and Framework. International Organisation for Standardization, Geneva, Switzerland.

- ISO. (2006b). ISO Standards for Life Cycle Assessment to Promote Sustainable Development - Ref.: 1019. Accessed from the International Organization for Standardization (ISO) website on 02/07/2010 at <http://www.iso.org/iso/pressrelease.htm?refid=Ref1019>.
- Jage, C. R., Zipper, C. E. and Noble, R. (2001). Factors Affecting Alkalinity Generation by Successive Alkalinity-Producing Systems: Regression Analysis. *Journal of Environmental Quality*. Vol. 30(2001). pp.1015–1022.
- Jones, R.N. (2001). An Environmental Risk Assessment/Management Framework for Climate Change Impact Assessments. *Natural Hazards*, 23 (2001), Kluwer Academic Publishers, pp. 197–230.
- Kaas, L. M. and Parr, C. J. (1992), Environmental Consequences. In: Hartman, H. L. (Ed.), *SME Mining Engineering Handbook*, 2nd Edition, Vol. 1, Society for Mining Metallurgy, and Exploration, Inc., Littleton, Colorado, USA, pp. 174-201.
- Kim S. and Dale, B.E. (2005). Life Cycle Inventory Information of the United States Electricity System, *Int. J. LCA*, Vol. 10, No. 4, Ecomed Publishers, Landsberg, Germany, pp. 294 – 304.
- Kim, S., Dale, B. E. and Jenkins, R. (2009). Life Cycle Assessment of Corn Grain and Corn Stover in the United States. *Int. J. LCA*, 14 (2009), Springer-Verlag, pp. 160–174.
- Kirchgessner, D. A., Piccot, S. D. and Masemore, S. S. (2000). An Improved Inventory Of Methane Emissions From Coal Mining In The United States United States. *Journal of the Air & Waste Management Association*, Vol. 50, No.11, pp. 1904-1919.
- Kral, S. (1993). Amax Coal's Delta Mine – Medium-Sized, High-Sulfur Operation Survives Markets Challenges. *Mining Engineering*, 1 January 1993, p.4. Retrieved 04/06/2010 from <http://www.onemine.org>.
- Krozer, Y. (2008) Life Cycle Costing for Innovations in Product Chains. *Journal of Cleaner Production*, Vol. 16, No. 3, Elsevier Ltd, pp. 310-321.
- Landis, A.E., Miller, S.A. and Theis, T.L. (2007). Life Cycle of the Corn-Soybean Agroecosystem for Biobased Production. *Environmental Science & Technology*, Vol. 41, No. 4, American Chemical Society, pp. 1457-1464.
- Larson, J. (2009). Indicating Impact: The Design of an Environmental Impact Labeling System for Consumer Goods. Ph.D. dissertation, University of Washington, United States - Washington. Retrieved March 24, 2010, from *Dissertations & Theses: A&I*(Publication No. AAT 3393962).

- Lesage, P., Ekvall, T., Deschenes, L. and Samson, R. (2007). Environmental Assessment of Brownfield Rehabilitation Using Two Different Life Cycle Inventory Models - Part 2: Case Study. *Int. J. LCA*, Vol. 12, No. 7, Ecomed Publishers, Landsburg, Germany, pp. 497-513.
- Lindeijer, E. (2000). Review of Land Use Impact Methodologies. *Journal of Cleaner Production*. Vol. 8 No. 4. Elsevier Ltd, pp. 273-281.
- Lindeijer, E. (2005). How Far Should We Improve Impact Assessment Methodology For Metal Mining? Illustrated With a Biodiversity LCIA Method. In: Dubreuil, A. (Ed.), *Life-Cycle Assessment of metals: Issues and Research Direction*, Proceedings of the International Workshop on Life-Cycle Assessment And Metals, April 2002, SETAC, Raleigh, North Carolina, USA, pp.123-131.
- Llyod, S.M. and Ries, R. (2007). Characterizing, Propagating, and Analyzing Uncertainty in Life-Cycle Assessment: A Survey of Quantitative Approaches, *Journal of Industrial Ecology*, Vol. 11. No. 1, Massachusetts Institute of Technology and Yale University, pp.161-179.
- Luba, L., Jakeman, M., Lefebvre, N. and Aseervatham, R. (2006). Mining For Water - Partnering For Sustainable Water Use In Semi-Arid Regions. *Proceedings of Water in Mining 2006 - Multiple Values of Water Conference*, November 14 - 16, 2006. Brisbane, Queensland, Australia. Australasian Institute of Mining and Metallurgy, pp. 199-203.
- Lumley, G. (2005). Reducing the Variability in Dragline Operator Performance, *Coal 2005: Coal Operators' Conference*, University of Wollongong & the Australasian Institute of Mining and Metallurgy, pp. 97-106.
- Lundie, S., Peters, G.M. and Beavis, P.C. (2004). Life Cycle Assessment for Sustainable Metropolitan Water Systems Planning. *Environmental Science & Technology*, Vol. 38, No. 13, American Chemical Society, pp. 3465-3473.
- Manderson, A.K. (2006). A Systems Based Framework To Examine The Multi-Contextual Application Of The Sustainability Concept. *Environment, Development and Sustainability*, 8(2006), Springer, pp. 85-97.
- Mangena, S.J. and Brent, A.C. (2006). Application of a Life Cycle Impact Assessment framework to evaluate and compare environmental performances with economic values of supplied coal products. *Journal of Cleaner Production*, 14 (2006), Elsevier Ltd, pp. 1071-1084.
- Matthews, M., Pearce, R., Chapman, J., Owili, G. and Mulyani, L., (2004). *Sustainability Reporting by the Mining Industry Compared With The Requirements of the GRI*. Gravity Graphics Publishers, Australia.

- Maurice, B., Frischknecht, R., Coelho-Schwartz, V. and Hungerbühler, K. (2000). Uncertainty Analysis in Life Cycle Inventory. Application to the Production of Electricity With French Coal Power Plants. *Journal of Cleaner Production* 8 (2000), Elsevier Science Ltd, pp. 95–108.
- McCarter, M. K. (1992), Surface Mining – Concurrent Reclamation. In: Hartman, H. L. (Ed.), *SME Mining Engineering Handbook*, 2nd Edition, Vol. 1, Society for Mining Metallurgy, and Exploration, Inc., Littleton, Colorado, USA, pp. 1403-1406.
- McLellan, B.C., Corder, G.D., Giurco, D. and Green, S. (2009). Incorporating Sustainable Development in the Design of Mineral Processing Operations – Review and Analysis of Current Approaches. *Journal of Cleaner Production*, Vol. 17, No. 16, Elsevier Ltd, pp. 1414-1425.
- Middleton, J. and McKean B.A. (2005). LCA of Nickel Products: Experience of the Industry. In: Dubreuil, A. (Ed.), *Life-Cycle Assessment of metals: Issues and Research Direction*, Proceedings of the International Workshop on Life-Cycle Assessment And Metals, April 2002, SETAC, Raleigh, North Carolina, USA, pp.47-51.
- Miller S.A., Landis, A.E., Theis, T.L. and Reich, R.A. (2007). A Comparative Life Cycle Assessment of Petroleum and Soybean-Based Lubricants. *Environmental Science & Technology*, Vol. 41, No. 11, American Chemical Society, pp. 4143-4149.
- Morris, L.A. (2005). Natural Resources Depletion Index. In: Dubreuil, A. (Ed.), *Life-Cycle Assessment of metals: Issues and Research Direction*, Proceedings of the International Workshop on Life-Cycle Assessment And Metals, April 2002, SETAC, Raleigh, North Carolina, USA, pp.109-113.
- Mudd, G. M. (2009). *The Sustainability of Mining in Australia: Key Production Trends and Their Environmental Implications for the Future*. Research Report No RR5, Department of Civil Engineering, Monash University and Mineral Policy Institute, Revised April 2009.
- Muga, H. (2009). *An Integrated Framework for Assessing the Sustainability of Components that Make Up the Built Environment*. Ph.D. dissertation, Michigan Technological University, United States - Michigan. Retrieved March 24, 2010, from Dissertations & Theses: A&I.(Publication No. AAT 3354978).
- NREL(2008). U.S. Life-Cycle Inventory Database. Accessed on 02/20/2010 at the National Renewable Energy Laboratory (NREL) website, <http://www.nrel.gov/lci/database/default.asp>.

- Olsen, S.I., Christensen, F.M., Hauschild, M., Pedersen, F. Larsen, H.F. and Tørsløv, J. (2001). Life Cycle Impact Assessment and Risk Assessment of Chemicals - A methodological Comparison. *Environmental Impact Assessment Review* 21(2001), Elsevier Science Ltd, pp.385-404.
- OSMRE. (2005). Final Environmental Impact Statement: Proposed Permit Application, BlackMesa-Kayenta Mine, Navajo And Hopi Indian Reservations, Arizona, Volume 1 Report, Office of Surface Mining Reclamation And Enforcement, OSM-EIS-25, Denver, Colorado, USA. Accessed on September 18, 2008 at <http://www.wrcc.osmre.gov/bmk-eis/1990EIS/90EISSummaryPrefaceTofC.pdf>.
- OSMRE (2008), Black Mesa Project: Final Environmental Impact Statement, Volume I, Office of Surface Mining Reclamation And Enforcement. OSM EIS-33. Accessed on 12 May 2009 at <http://www.wrcc.osmre.gov/WR/deis/FinalEIS.pdf>.
- Oswego Coal. (2008). Application for Surface Coal Mining Permit – Hume Mine. Oswego Coal Company Inc. December 11, 2008. Accessed on 09/14/2009 at the Missouri Department of Natural Resources offices in Rolla, MO, USA.
- Owens, J. W. (1997). Life-Cycle Assessment in Relation to Risk Assessment: An Evolving Perspective. *Risk Analysis*, Vol. 17, No. 3, Society for Risk Analysis, pp. 359-365.
- Pembina Institute. (2007). Life Cycle Value Assessments (LCVAs) and LCVA Training. accessed on 03/27/2010 at The Pembina Institute website <http://corporate.pembina.org/service/lcva>.
- Pennington, D.W., Potting, J., Finnveden, G., Lindeijer, E., Jolliet, O. , Rydberg, T. and Rebitzer , G. (2004). Life cycle assessment Part 2: Current Impact Assessment Practice. *Environment International* 30 (2004), Elsevier Ltd., pp. 721–739.
- Perez, F. and Sanchez, L. E. (2009). Assessing the Evolution of Sustainability Reporting in the Mining Sector. *Environmental Management* 43 (2009), Springer Science+Business Media, pp. 949–961.
- Pitterle, M. (2009). Evaluating and Enhancing Urban Wastewater System Sustainability. Ph.D. dissertation, University of Colorado at Denver, United States - Colorado. Retrieved March 24, 2010, from Dissertations & Theses: A&I.(Publication No. AAT 3360868).
- Rau, E.L. (1987). How Acid Rain Legislation Might Change Coal Use Patterns. *Mining Engineering*, 22 January 1987, Retrieved on 04/06/2010 from <http://www.onemine.org>.

- Raynolds, M., Fraser, R., and Checkel, D. (2000). The Relative Mass-Energy-Economic Value (RMEE) Method for System Boundary Selection – Part I: A Means to Systematically and Quantitatively Select LCA Boundaries, *Int. J. LCA*, Vol. 5, No.1, Ecomed Publishers, Landsburg, Germany, pp. 37-46.
- Rebitzer, G., Ekvall, T., Frischknecht, R., Hunkeler, D., Norris, G., Rydberg, T., Schmidt, W.-P., Suh, S., Weidema B.P. and Pennington, D.W. (2004). Life Cycle Assessment Part 1: Framework, Goal And Scope Definition, Inventory Analysis, And Applications. *Environment International* 30 (2004), Elsevier Ltd, pp. 701–720.
- Rebitzer, G. and Buxmann, K. (2005). The Role And Implementation Of LCA Within Life Cycle Management At Alcan. *Journal of Cleaner Production* 13 (2005), Elsevier Ltd, pp. 1327-1335.
- Rees, W.E. (1992). Ecological Footprints and Appropriated Carrying Capacity: What Urban Economics Leaves Out. *Environment and Urbanization*, Vol. 4. No.2, Sage, pp. 121-130. Retrieved on 03/05/2010 from <http://eau.sagepub.com>.
- Reich, M.C. (2005). Economic Assessment of Municipal Waste Management Systems— Case Studies Using a Combination of Life Cycle Assessment (LCA) and Life Cycle Costing (LCC). *Journal of Cleaner Production*, 13 (2005), Elsevier Ltd, pp. 253–263.
- Rio Tinto (2008). Rio Tinto Annual Report 2008. Accessed on 01/12/2010 at website <http://www.riotinto.com/annualreport2008/>.
- Ross, S., Evans, D. and Webber, M. (2002), How LCA Studies Deal With Uncertainty. *The Int. J. LCA*, Vol. 7. No. 1, Ecomed Publishers, Landsburg, Germany, pp. 47-52.
- Ruether, J.A., Ramezan, M., Balash, P.C. (2004) Greenhouse gas emissions from coal gasification power generation systems. *Journal of Infrastructure Systems*, Vol. 10, No. 3, American Society of Civil Engineers, pp. 111-119.
- SETAC (1997). Ecological Risk Assessment: SETACTIP Technical Issue Paper. Retrieved on 02/26/2010 at Society of Environmental Toxicology and Chemistry website at <http://www.setac.org/node/99>.
- Schreiber, A, Zapp, P. and Kuckshinrichs, W. (2009). Environmental Assessment of German Electricity Generation from Coal-Fired Power Plants With Amine-Based Carbon Capture. *International Journal of Life Cycle Assessment* 14 : (2009), Springer-Verlag, pp. 547–559.

- Smet, B. D. and Stalmans, M. (1996). LCI Data and Data Quality: Thoughts and Considerations. *Int. J. LCA*, Vol. 1, No. 2, Ecomed Publishers, Landsburg, Germany, pp. 96-104.
- Socolof, M.L., Overly, J.G., and Geibig, J.R.(2005). Environmental Life-cycle Impacts of CRT and LCD Desktop Computer Displays. *Journal of Cleaner Production*, 13 (2005), Elsevier Ltd, pp. 1281-1294.
- Sokka, L., Koskela, S. and Seppälä, J. (2005). Life Cycle Inventory Analysis of Hard Coal Based Electricity Generation. Finnish Environment Institute. Helsinki, Finland. Accessed on 02/04/2010 at [http:// www.environment.fi /publications](http://www.environment.fi/publications).
- Sonnemann, G., Castells, F. and Schuhmacher, M. (2004). Integrated Life-Cycle and Risk Assessment for Industrial Processes. *Int. J. LCA*, Vol. 9, No. 3, Ecomed publishers, Landsberg, Germany, pp. 206 – 207.
- Speth, J.G. (2002). The Global Environmental Agenda: Origins and Prospects in Global Environmental Governance Options & Opportunities. In: Esty, D.C and Ivanova, M.H. (Eds.), *Global Environmental Governance: Options and Opportunities*, Yale School of Forestry & Environmental Studies. Accessed on 01/16/2010 at www.yale.edu/environment/publications.
- Spitzley D.V. and Tolle D.A. (2004). Evaluating Land-Use Impacts: Selection of Surface Area Metrics for Life-cycle Assessment of Mining, *Journal of Industrial Ecology*, Vol. 8, No. 1-2, Massachusetts Institute of Technology and Yale University, pp. 11-22.
- Stewart, M. (2005). Application of LCA to Mining, Minerals, and Metals: outcomes of the MMSD Multi-stakeholder LCA Workshop. In: Dubreuil, A. (Ed.), *Life-Cycle Assessment of metals: Issues and Research Direction*. Proceedings of the International Workshop on Life-Cycle Assessment And Metals, April 2002, SETAC, Raleigh, North Carolina, USA, pp.12-14.
- Stewart, M. and Petrie, J. (2006). A Process Systems Approach to Life Cycle Inventories for Minerals: South African and Australian Case Studies. *Journal of Cleaner Production*, 14 (2006), Elsevier Ltd, pp. 1042-1056.
- Storm, S.K. (2009). A Winning Strategy for a Country with over 100 Years of Coal Fired Steam Generator Experience: Boiler Optimization. *American Coal*, Issue 2 (2009), American Coal Council, pp. 41- 44.
- Strauss, K., Brent, A.C., and Sibbele Hietkamp, S. (2006). Characterisation and Normalisation Factors for Life Cycle Impact Assessment Mined Abiotic Resources Categories in South Africa: The Manufacturing of Catalytic Converter Exhaust Systems as a Case Study. *Int. J. LCA*, Vol.11, No. 3, Ecomed publishers, Landsberg, Germany, pp. 162 –171.

- Tan, R.R., Culaba, A.B. and Purvis, M.R.I. (2002). Application of Possibility Theory in the Life-cycle Inventory Assessment of Biofuels. *Int. J. Energy Res.* 2002, 26, (DOI: 10.1002/er.812) John Wiley & Sons Ltd, pp. 735-745.
- Tedesco, S. (2003). Coalbed Methane Potential and Activity of the Western Interior Basin. AAPG Annual Convention, Salt Lake City, Utah, May 11-14, 2003. retrieved on 12/01/2010 at <http://www.searchanddiscovery.net/documents/abstracts/annual2003/extend/80125.PDF>.
- The University of Alabama (2010) States Capitals. Department of Geography, The University of Alabama. Retrieved on the June 7, 2010 at the website <http://alabamamaps.ua.edu/contemporarymaps/usa/basemaps/uscapz2.pdf>.
- Tillman, A.-M. (2000). EIA Procedure: Significance of Decision-Making for LCA Methodology. *Environmental Impact Assessment Review* 20 (2000), Elsevier Science Inc., pp. 113–123.
- Todd, J. A. (1996). Streamlining. In Curran M. A. (Ed.), *Environmental Life-cycle Assessment*, McGraw-Hill, New York, NY, USA.
- UN. (1998), Kyoto Protocol to the United Nations Framework Convention On Climate Change. United Nations. Accessed on September 19, 2009 at UN website at <http://unfccc.int/resource/docs/convkp/kpeng.pdf>.
- van Zyl, D.J.A. (2005). Towards Improved Environmental Indicators for mining Using Life-Cycle Thinking. In: Dubreuil, A. (Ed.), *Life-Cycle Assessment of metals: Issues and Research Direction*, Proceedings of the International Workshop on Life-Cycle Assessment And Metals, April 2002, SETAC, Raleigh, North Carolina, USA, pp.117-122.
- Vigon, B.W. (1996). Software Systems and Databases. In Curran M. A. (Ed.), *Environmental Life-Cycle Assessment*, McGraw-Hill, New York, NY, USA.
- von Below, M.A. (1993). Mining in the Era of Environmentalism. *Journal of the South African Institute of Mining and Metallurgy*, Vol. 93, No.1. South African Institute of Mining and Metallurgy, pp. 9-11.
- Wanichpongpan, W. and Gheewala, S.H. (2007). Life Cycle Assessment as a Decision Support Tool for Landfill Gas-to-energy Projects. *Journal of Cleaner Production*, 15 (2007), Elsevier Ltd, pp. 1819-1826.
- WCED (1987). Report of the World Commission on Environment and Development: Our Common Future - Annex to document A/42/427. World Commission on Environment and Development, Oslo, Norway, 20 March 1987, accessed on 02/12/2010 at <http://www.un-documents.net/wced-ocf.htm>.

- Weidema, B. (2001) Avoiding Co-Product Allocation in Life-Cycle Assessment. *Journal of Industrial Ecology*. Vol. 4, No. 1, Massachusetts Institute of Technology and Yale University, pp. 11-33.
- Widiyanto, A., Kato, S., Maruyama, N. and Kojima, Y. (2003). Environmental impact of fossil fuel fired co-generation plants using a numerically standardized LCA scheme. *Journal of Energy Resources Technology, Transactions of the ASME*, Vol. 125, No. 1, American Society of Mechanical Engineers, pp. 9-16.
- World Coal Institute (2005). *The Coal Resource: A Comprehensive Overview of Coal*. Retrieved on June 22, 2010, from World Coal Institute website at <http://www.worldcoal.org/resources/wci-publications/>.
- Worldsteel (2009). *About the Worldsteel Life Cycle Inventory*, March 12, 2009. Accessed on 03/02/2010 at World Steel Association (worldsteel) website at <http://www.worldsteel.org>.
- Worrall, R., Neil, D., Brereton, D. and Mulligan, D. (2009). Towards a Sustainability Criteria and Indicators Framework for Legacy Mine Land. *Journal of Cleaner Production*. Vol. 17, No. 16, Elsevier Ltd, pp. 1426–1434.
- Yang, B., Luo, Y. and Zhou, M. C. (2000). A Fuzzy Logic-Based Lifecycle Comparison of Digital And Film Cameras. In *Proceedings of 2000 IEEE International Symposium on Electronics and the Environment*, San Francisco, CA, May 2000, pp. 304-309.

VITA

Ofentse Ditsele was born in Molepolole, Botswana, on October 19, 1971. He did National Service (Tirelo Sechaba) from January to December 2001, followed by Pre-Entry Science Course at the University of Botswana from January to July 2002. He did two years of BSc. (General Science) at the same university from 2002-2004, before transferring to Queen's University, Kingston, Ontario, Canada, where he received his Bachelor of Science in Mining Engineering in May 1998. Upon graduation, he worked with the Department of Teaching Service Management as a temporary teacher (teaching general science) at Boipelogo Community Junior Secondary School, in Serowe, Botswana. He joined the Government of Botswana's Department of Mines, Inspectorate Division, in November 1998. He started in the Department as an Assistant Government Mining Engineer, rose through the ranks, and is currently a Principal Engineer I, heading the Department's regional office in Francistown. He has worked at a number of mining operations in Botswana on secondment from the Department of Mines, and these include, Gaborone Quarry, BCL Limited mines, Debswana Diamond Company's Morupule Colliery and Orapa mine. In August 2010 he received his Master of Science in Mining Engineering from Missouri University of Science and Technology, Rolla, Missouri. USA.